

The SHORT WAVE Magazine

VOL. XIX

FEBRUARY 1962

NUMBER 12

the best there is and you can build it yourself
with Hallikits

Build your own station, using the finest equipment available — at a price you can afford. Hallicrafters, the name to remember for top quality S/W equipment, now present their latest transmitter (H.T.40) and receiver (SX140) in KIT FORM. You can cut down expense and build yourself equipment to be proud of.

SPECIAL OFFER — £20 REDUCTION

IF HALLIKIT TRANSMITTER AND RECEIVER ARE ORDERED TOGETHER IN FEBRUARY AND MARCH ONLY.

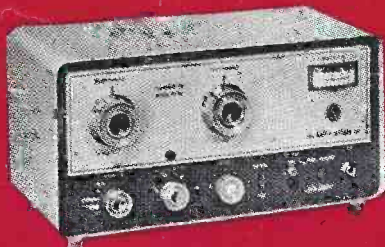

H.T.40K TRANSMITTER

A handsome instrument giving excellent CW and AM performance. 75 watts D.C. output T.V.I. filtered. Fully band-switched for the 80, 40, 20, 15 and 10 metre amateur bands. Valve line up: 6DQ5PA; 6CX8 crystal OSC. and driver; 12AX7 Speech amp.; 6DE7 modulator; silicon H.T. rectifiers. Kit price £45 (Fully wired and tested £52).

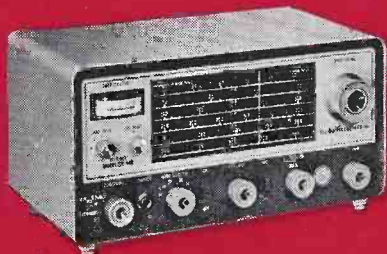

SX.140K RECEIVER

Specially designed for operation with the H.T.40 this receiver covers the amateur bands from 80-10 metres and the American 6 metre band.

Features

High sensitivity; sharp selectivity; complete with R.F. stage, S-metre, aerial trimmer and crystal calibrator, tuning ratio 25:1. Kit price £50 (Fully wired and tested £56 10s.).



S-108

An inexpensive unit which incorporates the features normally found in larger models. Included in the S-108 are a temperature compensated oscillator and bandspread calibration for 10, 15, 20, 40, and 80 metre Amateur Bands.

Features

Slide rule bandspread calibrated on 10, 15, 20, 40 and 80 metre amateur bands. One R.F., two I.F., and separate bandspread tuning condensers. Temperature compensated oscillator and built-in speaker. Frequency coverage: Broadcast Band 540 - 1500 Kc plus three S.W. Bands 1550 Kc - 8.4 Mc.

Price £70

HIRÉ PURCHASE TERMS AVAILABLE

SCOTT'S

James Scott (Electricity Service Centres) Ltd
175 St. Vincent Street, Glasgow C.2
Tel: City 3181

H. WHITAKER G3SJ

Court Road - Newton Ferrers - SOUTH DEVON

Telephone 320
Newton Ferrers

(A.R.B. APPROVED)

Precision crystals of all types in a wide variety of bases covering the complete range 50 kc/s to 18 mc/s in fundamental frequencies. All are made to extremely fine tolerances and frequency adjustment can be given up to .005%. Plated electrodes of gold, silver, or aluminium with wired in spot welded contacts are available. Quotations can be given for any type of cut, or mode of oscillation, including a complete range of filters with zero temperature co-efficient over a sensibly wide temperature range.

Special Offer :

400 crystals in the range 7100 to 7150 kc/s inclusive. Brand new and unused post-war production. Specification : BT cuts, zero temperature co-efficient, gold plated electrodes, wired into FT 241 type holders with standard $\frac{1}{2}$ " pin spacing. Accurately calibrated. Better than average activity, EPR is better than 14 K. Ohms at 30 pf. input capacity. Price 18/- each, post free. All fully guaranteed and unrepeatable at today's prices. The offer applies only to the range mentioned above, all frequencies between 7100 and 7150 kc/s available.

VHF ENTHUSIASTS

No more chains of doublers ! A complete new range of crystals for DIRECT output up to 74 mc/s when using only a simple RF pentode oscillator such as Z77, EF80, etc., full details of this range on request.

TAKE YOUR PICK

FROM TWO OUTSTANDING LABGEAR PRODUCTS

LG50 (3.5-30 Mc/s)

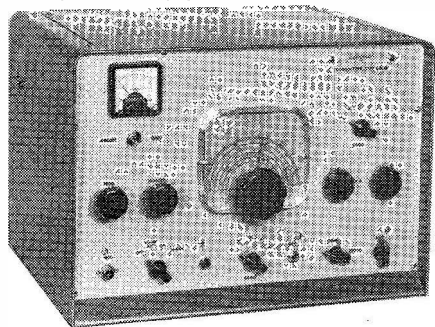

Featuring :-

- ★ PRINTED CIRCUIT RELIABILITY
- ★ 10-15-20-40-80M. Band Switched
- ★ 60 Watts C.W.
- ★ 40 Watts Phone
- ★ 75 ohms co-ax output
- ★ Full "netting" facilities
- ★ Completely self-contained with modulator and A.C. mains power supply

A complete 50 Watt Transmitter for only 45 gns. or on easy terms

Topbander (1.8-2.0 Mc/s)

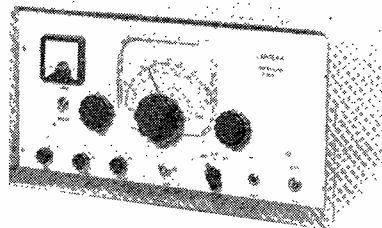

MARK II VERSION

Featuring :-

- ★ PRINTED CIRCUIT RELIABILITY
- ★ Plate and Screen Modulation resulting in considerably increased Talk Power
- ★ Improved ease of operation
- ★ Calibrated V.F.O. 1.8-2.0 Mc/s.
- ★ Maximum legal input on both Phone and C.W.
- ★ 75 ohms co-ax output
- ★ Completely self-contained with modulator and A.C. mains power supply

Price 28 gns. or on Easy Terms

Send S.A.E. for full specifications

LABGEAR LIMITED

CROMWELL ROAD, CAMBRIDGE,
ENGLAND

Telephone : 47301 (4 lines).

Telegrams and Cables : "Labgear Cambridge"

CQ . . . CQ . . . CQ . . . HAMS



QTR ?

**Time you
bought a**

MULTIMINOR

OM !



Pocket Size : 5 1/2 x 3 1/2 x 1 1/2 inches.
Weight : 1 lb. approx.

RANGE SELECTION :

Range selection is by means of a substantial switch, there being only two connection sockets for any measurement. The instrument has 19 ranges, a single scale being provided for current and voltage measurements and another for resistance measurements.

D. C. Voltage	A.C. Voltage	D.C. Current
0— 100 mV.	0— 10 v.	0— 100 micro A
0— 2.5 V.	0— 25 v.	0— 1mA
0— 10 V.	0— 100 v.	0— 10mA
0— 25 V.	0— 250 v.	0— 100mA
0— 100 V.	0— 1000 v.	0— 1 A
0— 250 V.		
0— 1000 V.		

Resistance
0—20,000 ohms
0— 2 M/ohms

Sensitivity :

10,000 ohms per volt on D.C. voltage ranges.
1,000 " " " " A.C. " " "

Accuracy :

On D.C. 3% of full scale value.
On A.C. 4% " " " "

To meet special requirements, instruments can be supplied to higher degree of accuracy for a small additional charge.

This is an ingeniously designed yet inexpensive rectifier/moving coil instrument of pocket size and sturdy construction. It is extremely well made and simple to use.

Two models are available, Model 1 for use in temperate climates, and Model 2 for use under adverse climatic conditions.

It is fitted with a high-grade rotary selector switch of quite unique design, in which a series of 18 fixed silver-plated contacts, embedded in a moulded ring, are wiped by a double-contact rotor arm.

Full advantage has been taken of the latest printed resistor techniques to achieve compactness of size and economy of weight.

Specially designed extremely accurate test gear has been made to ensure that every Multiminator measures up to the prescribed standards of accuracy, and the final testing is of a particularly rigorous nature.

List Price : **£9 : 10s.** complete with Test Leads and Clips.

Leather Case if required 39/-

• Write for fully descriptive leaflet.

AVO LTD

AVOCET HOUSE . 92-96 VAUXHALL BRIDGE ROAD . LONDON . S.W.1

M A MEMBER OF THE METAL INDUSTRIES GROUP OF COMPANIES

TECHNICAL PUBLICATIONS

Available from stock

LATEST ISSUES

Latest Edition of the

RADIO HANDBOOK (15th Edition)Published by *Editors & Engineers*, W6-U.S.A. 800 pages, durable binding.
Price 68s. 6d. post free, from stock**RADIO AMATEUR CALL BOOK**The CALL BOOK is published in two parts: *American* Section only, at 45s. post free; *Foreign* (non-American) Section at 27s. post free. Both Editions appear quarterly and include latest call sign/address listings for all countries, with much DX data. The only complete directory to the radio amateur stations of the world*American* Section, Winter Edition 45s.; *Foreign* (non-American) Section Winter Edition, 27s. available now

The two together at 65s. post free

THE RADIO AMATEUR'S HANDBOOK

1961 EDITION — 700 pages fully indexed

Published by the American Radio Relay League
(See review p. 421 October issue)

Buckram Edition only, 44s. 6d. post free

DX ZONE MAP (Latest Revision)

(Great Circle, centred U.K.)

Linen Backed (de luxe) 11s. 9d. post free

AMATEUR RADIO MAP OF WORLD

(Mercator Projection)

Much DX Information — In Colour, 8s. 6d. post free — Second Edition

WORLD SHORT WAVE RADIO MAP

(General SWL and BC coverage, with handbook) 8s. 6d. post free

Magazines by subscription

73 MAGAZINE	One Year	30s. 0d.
AUDIO		40s. 0d.
*CQ, RADIO AMATEUR'S JOURNAL		44s. 0d.
ELECTRONICS (Trade only)		160s. 0d.
POPULAR MECHANICS		39s. 0d.
POPULAR SCIENCE		52s. 0d.
QST, ARRL		48s. 0d.
HIGH FIDELITY		58s. 0d.
ELECTRONICS WORLD		
(formerly "Radio and Television News")		48s. 0d.
RADIO ELECTRONICS		52s. 0d.
"ELECTRONIC TECHNICIAN" (Trade only)		65s. 0d.
TELEVISION		55s. 0d.

Post free, ordinary mail only

*Binders for CQ 30s. 0d.

Subscription Service for all American Radio and Technical Periodicals

SHORT WAVE MAGAZINE

Publications Department

55 VICTORIA STREET, LONDON, SW1

Abbey 5341

Post Free

AMATEUR RADIO HANDBOOK (new Publication by R.S.G.B.), 550 pages.....	36s. 6d.
ANTENNA HANDBOOK (Published by A.R.R.L.) (9th Edition).....	19s. 0d.
A COURSE IN RADIO FUNDAMENTALS (4th Edition).....	10s. 6d.
AUTOMOBILE ELECTRICAL EQUIPMENT.....	31s. 0d.
BASIC MATHEMATICS FOR RADIO AND ELECTRONICS.....	18s. 3d.
BEAM ANTENNA HANDBOOK.....	24s. 6d.
BETTER SHORT WAVE RECEPTION.....	24s. 0d.
CALL BOOK (G's only).....	5s. 0d.
CHART OF INTERNATIONAL FREQUENCY ALLOCATIONS — GENEVA, 1960 (Official), 10 Kc-40 Gc, 51" x 34", wall mounting.....	8s. 3d.
COMMAND SETS (Published by CQ) Information on conversion of many Command Transmitters and Receivers.....	12s. 6d.
CQ ANTHOLOGY.....	16s. 9d.
DXERAMA (3rd Edition).....	16s. 0d.
FOUNDATIONS OF WIRELESS.....	17s. 3d.
GUIDE TO BROADCASTING STATIONS (13th Edition) pp. 112.....	3s. 10d.
HAMS INTERPRETER (Published by QFZSO) (4th Edition).....	7s. 0d.
HINTS AND KINKS, Vol. 6.....	11s. 0d.
HOW TO BECOME A RADIO AMATEUR★.....	5s. 0d.
HOW TO LISTEN TO THE WORLD, 1962.....	12s. 6d.
HOW TO GET THE BEST OF YOUR TAPE RECORDER.....	9s. 1d.
LEARNING MORSE.....	1s. 9d.
LEARNING THE RADIO TELEGRAPH CODE.....	4s. 6d.
LOG BOOKS Spiral bound (Published by A.R.R.L.)★.....	7s. 6d.
MOBILE HANDBOOK (Published by CQ) (2nd Edition).....	24s. 0d.
MOBILE MANUAL (Published by A.R.R.L.).....	23s. 0d.
NEW SIDEBAND HANDBOOK (Published by CQ, latest issue).....	25s. 6d.
NOVICE HANDBOOK, Tx and Rx, 150 pages OPERATING AN AMATEUR RADIO STATION (Published by A.R.R.L.)★.....	2s. 8d.
PORTABLE TRANSISTOR RECEIVER.....	3s. 0d.
QUAD ANTENNAS.....	23s. 0d.
RADIO AMATEUR YEAR BOOK.....	4s. 0d.
RADIO AMATEURS' EXAMINATION MANUAL.....	5s. 6d.
RADIO CONTROL HANDBOOK.....	18s. 9d.
RADIO DATA CHARTS.....	11s. 3d.
RADIO DESIGNERS' HANDBOOK (4th Edition) 1,498 pp. (F. Langford Smith).....	57s. 6d.
RADIO AND ELECTRONIC LABORATORY HANDBOOK (7th Edition, by Wireless World).....	57s. 3d.
RADIO INTERFERENCE SUPPRESSION.....	11s. 3d.
RADIO VALVE DATA (New Edition now available, 4,800 types listed).....	6s. 6d.
S-9 SIGNALS.....	8s. 6d.
SCATTER PROPAGATION THEORY AND PRACTICE (H. W. Sams).....	25s. 0d.
SHORT WAVE RECEIVERS For the Beginner.....	6s. 6d.
SHORT WAVE AND THE IONOSPHERE.....	11s. 9d.
SINGLE SIDEBAND FOR THE RADIO AMATEUR (A.R.R.L.).....	14s. 6d.
STEREO HANDBOOK.....	11s. 4d.
SURPLUS SCHEMATICS (Published by CQ).....	21s. 0d.
SURPLUS HANDBOOK (See p. 420, Oct. '61).....	24s. 0d.
SURPLUS CONVERSION MANUAL.....	
Volume 1 (3rd Edition).....	24s. 0d.
Volume 2.....	24s. 0d.
Volume 3.....	24s. 0d.
TELEVISION EXPLAINED.....	13s. 6d.
THE OSCILLOSCOPE.....	18s. 6d.
THE RADIO AMATEUR OPERATOR'S HANDBOOK (Data Publications) (New Edition).....	3s. 10d.
TRANSISTORS: THEORY AND PRACTICE (Published by Gernsback).....	23s. 0d.
TRANSISTOR THEORY AND PRACTICE (Published by World Radio Handbook).....	9s. 6d.
TRANSISTOR TECHNIQUES (Gernsback).....	12s. 6d.
VHF HANDBOOK (Orr W6SA1).....	24s. 0d.
VHF FOR THE RADIO AMATEUR (CQ).....	28s. 0d.
WORLD RADIO HANDBOOK, 1962 Edition, 216 pages.....	19s. 0d.

(★ Not strictly applicable under U.K. conditions)

IMAGINATIVE DESIGN CONCEPT

PRODUCES COMPACT, LOW COST SSB, AM,
CW COMMUNICATIONS RECEIVER WITH
FINE RECEIVER PERFORMANCE



Now the leading manufacturer of quality amateur radio aerials offers you tried and proved components in the new Mosley CM-1 Communications Receiver. But – FOR THE FIRST TIME – these have been combined so as to result in performance equal to or better than that of receivers selling for several times the price.

Stop at the Mosley booth and see the powerful new CM-1 at the Radio Hobbies Exhibition, November 22–25.

Clean, functional panel layout and compact cabinet of receiver and speaker will complement the finest Amateur Station. Baked on dukane grey and black enamel over heavy gauge steel. Receiver: 10½" x 7½" x 8" deep. Speaker: 7½" x 7½" x 8" deep.

FEATURES and PERFORMANCE:

Double conversion with crystal controlled first oscillator. All necessary crystals included.

Diode detector for AM and product detector for SB and CW.

Covers complete range of all amateur bands – 80 metres through 10 metres. Ten metre band segmented in three overlapping increments of 650 kc. each. Each band and each segment covers full 12" dial scale.

Receiver is equipped with an automatic noise limiter which is very effective against impulse noises.

Calibration every 5 kc. WWV reception at 15 mc.

S-meter functions on AM, CW or SSB, with or without BFO.

Five dual-purpose valves plus four semi-conductor diodes provide functions of 12 valve sections.

VALVE and DIODE LINEUP: One 6AW8A, triode mixer and crystal oscillator; one 6AW8A, 2nd mixer and tunable oscillator; one 6AW8A, 1st IF and 1st Audio; one 6AW8A, 2nd IF and product detector; one 6AW8A, 2nd audio and BFO; 1N34, AM detector; 2F4, power rectifier; two 1N54A's, noise limiter.

SELECTIVITY: 2.5 kc. at -6 db.

SENSITIVITY: ½ microvolt for 10 db. signal-to-noise ratio on ten metres.

STABILITY: Less than 500 cycles drift after one-minute warm-up. Less than 200 cycles change for 10% line voltage change. Temperature compensated and voltage regulated.

IMAGE and IF REJECTION: 35 db. minimum.

AUDIO OUTPUT: ½ watt at 6% distortion.

REAR CHASSIS ACCESSORY FACILITIES: Transmitter Relay Terminals, Accessory Power Socket, External Speaker/VOX Terminals.

POWER CONSUMPTION: 33 Watts. (230 volts AC, 50 to 60 cps.)

Net Price only £86

Matching Speaker Model CMS-1 extra.

<p>AUSTRALIA MAGNECORD AUSTRALASIA PTY. LTD. Kyle House, 31 MacQuarie Place, Sydney</p>	<p>DENMARK HANS HOLTMAN, OZ9DC SØBAKKEN 21, Charlottenlund</p>	<p>RHODESIA STUDIO FOUR Salisbury, Rhodesia</p>	<p>FINLAND OSMO A. WIILO, OH2TK Laajalahdentie 24 A1, Mukkiniemi</p>
<p><i>(Write to your local distributor for price outside the United Kingdom)</i></p>			

Mosley Electronics Ltd. 15 Reepham Road, Norwich, Norfolk, Telephone 45069

O. J. Russell, G3BHJ, Manager

PETER SEYMOUR

COMMUNICATION EQUIPMENT SPECIALISTS

	£	s.	d.
Never before offered BRAND NEW AR88D with tools, manual, in original packing cases (P/P £1)	75	0	0
AR88LF in first-class condition (P/P £1)	35	0	0
EDDYSTONE 680X , 480 Kc-32 Mc (P/P £1)	85	0	0
EDDYSTONE 750 , Latest version, Double superhet. (P/P £1)	45	0	0
EDDYSTONE 358X with ten coils, as new 40 Kc-30 Mc. And spares	17	10	0
NATIONAL HRO50TI with general coverage/bandspread coils 1.7-30 Mcs. 100/1000 Kc. calibrator Nb Fm adaptor. As new	135	0	0
HRO MX with power unit and 8 coils including 80/40/20/10 metre bandspread	25	0	0
CLASS D No. 2 Heterodyne frequency meters. Latest version of the class D. Complete with spares kit, headphones, calibration charts and instruction manual. Power input 100-250v.A.C. or 12v.D.C. 1.2-19.2 on fundamentals. Unused and storage soiled only. A first-class signal generator (P/P 10/-)	7	10	0
COLLINS TCS receivers, Grade A as new (P/P 10/-)	8	10	0
1.5-12 Mc. " B (P/P 10/-)	5	10	0
" C no guarantee (P/P 10/-)	3	10	0
HEATHKIT DX40 and VFIU , 80-10 Mtrs. 6146 PA	35	0	0
MINIMITTER 150V. TX, TVI proof. 200-250v. A.C. input. 80-10 (P/P £2)	35	0	0
I392D VHF receivers, 100-156 Mc. 15 Valves. 5 meter, etc. (P/P £1)	3	10	0
NATIONAL NC44 , 540 Kc.-30 Mc. (P/P £1)	17	10	0
FREQUENCY MULTIPLIER AMP . Input 30 Mc., output in 420 Mc. band, complete with valves and circuit	5	0	0
ADVANCE EI SIGNAL GENERATOR . 100 Kc.-60 Mc. 200-250 A.C. input	10	0	0
R206 in first-class condition in transit case, 10-60 Mc. built-in speaker and power unit for 100-250 A.C. or 6v.D.C. (P/P £1)	8	10	0
R107 . 1.2-18.5 Mc., built-in speaker, power unit, 5 meter (P/P £1)	10	0	0
CR300 . 15 Kc.-25 Mc. speaker and original power unit	25	0	0
PHILIPS transistorised car radio. 12v. D.C.	10	0	0

HIRE PURCHASE TERMS TO SUIT YOU

20% deposit balance up to 24 months on equipment over £35 inclusive.

Part exchanges. Export to any part of the world.

410 BEVERLEY ROAD, HULL, YORKSHIRE

Telephone: Hull 41938

NATIONAL RADIO

	£	s.	d.
CR100	17	10	0
AR88D	37	10	0
AR88LF	35	0	0
CR150 and P/pack	30	0	0
DST100 and P/pack	17	10	0
HRO Rx	12	10	0
Power Pack	3	10	0
Coils	1	10	0
R.107	13	0	0
BRT 400	75	0	0
Tiger 60	47	10	0
Tiger 150	85	0	0
Avo Valve Tester	4	10	0
BC221	15	0	0

Please add 10s. towards packing and sending

NOTE NEW ADDRESS

6 SHIRLEY ROAD, SOUTHAMPTON

Telephone 21640

BROOKES Crystals

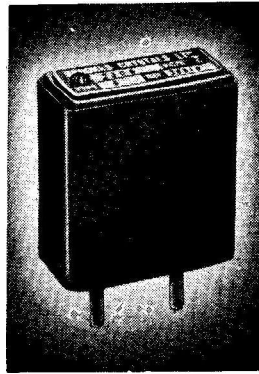

mean
DEPENDABLE
frequency
control

Illustrated is a Type S Crystal unit from a range covering 100 kc/s to 15 Mc/s.

- Black bakelite case.
- 1 3/4" high x 1 1/8" wide x 3/4" thick.
- Two 1/8" dia. pins spaced 3/4" centres.

ALL Brookes Crystals are made to exacting standards and close tolerances. They are available with a variety of bases and in a wide range of frequencies. There is a Brookes Crystal to suit your purpose—let us have your enquiry now.



BROOKES CRYSTALS (1961) LTD.

Suppliers to Ministry of Supply, Home Office, BBC, etc.

CORNHILL FACTORY, ILMINSTER, SOMERSET

Tel.: Ilminster 402

• Southern Radio's Wireless Bargains •

PORTABLE TEST METERS. 0-5000 ohms ; 0-60 m.a.; 0-1.5v. 0-3V. (Featured in Practical Wireless, March issue). 12/6 each

TRANSMITTER RECEIVERS TYPE "38" with 5 valves. New but untested, no guarantee..... 25/- each. Post paid.

ATTACHMENTS FOR "38" TRANSMITTER-RECEIVER : HEADPHONES, 15/6; THROAT MICROPHONES, 4/6; JUNCTION BOXES, 2/6; AERIALS: No. 1 2/9, No. 2 5/3; WEBBING, 4/-; HAYERSACKS, 5/6; VALVES—A.R.P.12, 4/6, A.T.P.4, 3/6; SET OF FIVE VALVES, 19/- . Postage on each item, 1/6 extra (except valves).

ATTACHMENTS for "18" Transreceiver. HEADPHONES, 15/6; MICROPHONE 4s, 12/6; AERIALS, 5/-; MORSE KEY, 6/6; VALVES—ARPI2, 4/6, ATP4, 3/6, AR8, 7/6; SET OF SIX VALVES, 25/- . Postage extra (except Valves) 1/6 each item.

OFFICIAL BOOKLET. "18" T-R Circuits, etc., 6/6, post paid.

QUARTZ CRYSTALS. Types F.T.241/F.T.243. 2-pin 1/4" spacing. F.T.241, 20 to 38.9 mc/s. (54th and 72nd Harmonic). F.T.243, 5700 to 8650 kc/s. (Fundamental), 4/6 each. Lists of available frequencies on request. Crystal Holders for F.T.241/243, 1/3. F.T.241/243 Crystals New but not guaranteed (Ideal for using the case or regrounding), 12/6 per dozen, post paid.

RECORDING BLANKS. New 13", 6/- each or 15 complete in tin £4

BOMBIGHT COMPUTERS. Ex-RAF. Wealth of gears, motors, blowers, etc. Ideal for experimenters £3/12/6 carr. paid

RESISTANCES. 100 Assd. Useful values, new 12/6 per 100

CONDENSERS. 100 Assorted. Mica, Elec., Tubular, etc. New 15/- per 100

MORSE PRACTICE SETS. Key with Buzzer on Base, with battery 12/6, postage 2/

LUFBRA HOLE CUTTERS. Adjustable. 3/4" to 3 1/4" 7/3

STAR IDENTIFIERS. I-AN: covers both Hemispheres ... 5/6

VISUAL INDICATORS (IOQ4). Type 3 with 2 Meter movements, 2 Neons, New 12/-

MAGNETS. Strong Bar. 2" x 1/4" 1/6 each

COMMAND RECEIVERS. B.C. 455 6-9 Mc/s. Complete with 6 valves..... 47/6 each

Post or Carriage Extra. List of Radio Publications, etc., 3d.

SOUTHERN RADIO SUPPLY LTD

11 LITTLE NEWPORT ST., LONDON, W.C.2. GER 6653

Who are the Tigers?

Since this Company changed hands in 1960, the range of Tiger products has increased enormously and all the old 8VB designs have been superseded. We are professional Amateurs, whose only wish is to provide you with the equipment you want.

G2FQT — Designer of the TIGER TR 100, TR 150X, TR200X and TIGRESS Transmitters.

G2YH — Designer of the 2 metre converters and the TR2M. An acknowledged expert in the VHF field.

G2FK — Leads the workshop team.

Tiger Transmitters

TR2M — QRO 2-metre transmitter—QQVO6/40 PA, KT88 modulators, crystal control. 100 watts input on 5 spot frequencies. **80 guineas**

TIGRESS — 10-80 metres, 6146 PA, KT77 modulators. Compact and simple to operate. **57 guineas**

TR100 — 10-160 metres, TT21 PA, KT88 modulators, 10 or 100-120 watts input. **£87. 10. 0**

TR150X — 10-80 metres, TT21 PA, KT88 modulators. Superb appearance. **£105**

TR200X — The luxury AM/CW transmitter. **£170**

Linear Amplifiers, 2 Metre Converters, Antenna Couplers, SWR Meters, and Band Edge Markers Supplied

Available Shortly — 160 Metre Transistor Transmitter

WOLFENDALE & HOBDEN trading as

TIGER RADIO LIMITED

36A KIMBERLEY ROAD, SOUTHBOURNE, BOURNEMOUTH, HANTS.

Telephone — Bournemouth 48792

G.W. SMITH & CO. (RADIO) LIMITED

Phone: GERRARD 8204/9155
Cables: SMITHEX LESQUARE
3-34 LISLE STREET, LONDON, W.C.2

P.C.R. COMMUNICATION RECEIVERS. 6 valves. Frequency coverage on three bands:— 850-2,000m., 190-550m., 6-18 mc/s. Super slow motion drive. Aerial trimmer, volume and tone controls. Output for 3 ohm speaker or phones. Available as follows:— AS NEW WITH BUILT-IN SPEAKER, £6/19/6, carriage 10/- extra on all models. All models can be supplied with a built-in power unit for operation on 200/250 volts A.C. at an additional cost of 39/6 or alternatively the original plug-in A.C. mains power units are available at 35/- extra.

R.C.A. PLATE TRANSFORMERS. Primary 200/250 volts. Secondary 2,000-1,500-0-1,500-2,000 volts. 500Ma. New and boxed, £6/10/- each, carriage 10/-.

PARMEKO TABLE TOP TRANSFORMERS. Primary 230 volts. Secondary 620-0-620 volts. 250Ma tapped 550 and 375 volts, 5 volt 3 amp, 5 volt 3 amp. New, boxed, 45/- each, carriage 5/-.

CLASS D WAVEMETERS, MARK II. Frequency coverage 1,900 kc/s. to 8,000 kc/s., 6 volt D.C. input. Supplied brand new with instructions, 59/6 each. P/P 3/6.

MINE DETECTORS, No. 4A. Will detect all types of metal. Supplied complete and tested with instructions, 39/6 each. Carriage 10/-.

FIELD TELEPHONES, TYPE F. Ideal for all intercom systems. Two line connection. Supplied fully tested and complete with batteries and wooden carrying case, £4/19/6 per pair. P/P 5/-.

UNIVERSAL AVOMETERS. All models are offered in first class condition throughout, fully tested and checked, guaranteed perfect and are supplied with instructions, leads and batteries.

MODEL "D" — 34 RANGE	£8/19/6
MODEL "7" — 50 RANGE	£11/10/0
MODEL "8" — 20,000- \sqrt VOLT	15 gns.

Registered post 5/- extra on all models.

HETERODYNE FREQUENCY METER D, No. 2. Frequency coverage 1.2-19.2 mc/s. Operation 12 volts D.C. or 230 volt A.C. Supplied complete with calibration charts, crystal, valves, leads and some spares, £6/19/6 each, carriage 10/-.

BRAND NEW 100 MICROAMP METERS. Standard 2 1/2" flush panel mounting. Calibrated 0-100 microamp, 42/6 each. P/P 1/3.

MINIATURE PANEL METERS. Entirely new range of meters with clear plastic cases. 1 1/2" x 1 1/2" square fronts. Panel hole 1 1/4" dia. Brand new guaranteed.

50 microamp	39/6
500 microamp	32/6
milliamp	27/6
V/U meter — 20-0-+ 3VU	42/6

"S" meter. Range "S" units:—
0-9 terminating + 10 and + 30 db.
0-5 and 0-10 linear scale ... 35/-

G.E.C. SELECTEST MULTI-RANGE TEST-METERS. 1,000- \sqrt /volt A.C./D.C. 37 ranges. Fitted with automatic cut out. Supplied in perfect order complete with batteries and leads, £9/19/6 each. Registered post 5/- extra.

P.C.R.3 COMMUNICATION RECEIVERS Frequency coverage, medium wave and 2-7 and 7-22 mc/s. O/P for 3 ohms. Supplied in as new condition, fully tested, 8 gns. each, carr. 10/-.

If required with built-in 200/250v. A.C. power pack add 39/6.

AR-88 L.F. RECEIVERS. World famous receiver offered in first class condition, fully reconditioned. Frequency coverage 75 kc/s. to 550 kc/s. and 1.5 mc/s. to 30 mc/s. Operation 110-200-250 volts A.C. Price £32/10/0 each, carriage 30/-.

AR.88D SPARES. Complete wavechange switch assembly complete with screens, new and boxed, 17/6 each. P/P 2/6. New and boxed, 1st I.F. transformers, 3/6 each. P/P 9d.

R206 RECEIVERS. Frequency coverage on 6 bands, 550 kc/s. to 30 mc/s. All usual facilities. Built-in power supply and speaker. Supplied brand new, £17/10/- each. Carriage £2.

C.R.100 SPARES KITS. Contains 15 valves, resistor and condenser packs, pots, output transformer, etc. All new and boxed, 59/6 each. P/P 3/6.

COLLARO STUDIO TAPE TRANSCRIBERS. Latest model, three speeds, 1 1/2, 3 1/2 and 7 1/2. Supplied brand new guaranteed with instructions and 7" spare spool. Price 10 gns. P/P 3/6.

NATIONAL H.R.O. RECEIVERS. Senior model, table mounting. Supplied with complete set of 9 coils covering 50 kc/s. to 30 mc/s. Supplied in first class condition, fully reconditioned, 21 gns each, carriage 10/-.

Power units to operate on 200-250 volts A.C., extra 59/6

TESTGEAR COMPONENTS (London) LTD

2 & 4 Earlham Street, London, W.C.2. (Cambridge Circus)

A few minutes walk from Leicester Square or Tottenham Court Road Underground Stations.

Telephone No. TEM 1189.

HOURS OF BUSINESS. Open 9 a.m. to 6 p.m. Monday to Friday. Saturday 9 a.m. to 1 p.m.

BELLING LEE THERMAL CUT-OUTS. Available in 1, 1.5, or 2 amps. Price 1/6 each.

A.P.N.I. RADIO ALTIMETER. A 420-460 Mc/s. Radar Set, complete with 14 valves and 3 relays. Price 25/-, 24v. Dynamotor, 7/6 extra. Transmitter Unit, ex above, includes two 995 Acorns and Transducer, as used in Wireless World Wobulator. Price 6/6. Receiver Unit, ex above, includes two 9004 Acorns. Price 5/-, Audio amp., ex above, includes two 12SH7. Price 5/-.

RECTIFIERS. Contact cooled bridge rectifiers output 250v. 120 mA. Price 5/6. Transformer for same with 6.3v. 3A. winding. Price 8/6.

VALVES. We carry comprehensive stocks of all popular R/X and T/X tubes. TT21, TT22, 6146, etc. A few examples of our low prices. 6AG7, 5U4, 6AK5, QV04/7, 6AQ5, 6SL7, 6SN7, 12AX7, 12AU7, All 5/- each. 616, 6AM5, 6AM6, 6C4, EF80, 6SK7, 1625. All 2/6 each. 807, 7/6 each. 12SH7, 6AC7, 12SJ7, 717A, EF50, EF54, 955, 9004. All 1/6 each. Hundreds of other types available at similar prices.

FT.241 CRYSTALS. Channels 270 to 322 and 341 to 389 (except 360) are 2/6 each. Channels 323 to 340 are 7/6 each.

CRYSTAL FREQUENCY STANDARDS. 10X type. 500 K/c., 7/6. 1,000 K/c., 15/-, 2 Mc/s., 7/6. 5 Mc/s., 5/-.

50 MICROAMP METERS. Made by Sangamo Weston. Brand new. Type S.145. Size: 3" x 2 1/2". 850 ohms resistance. Four scales operated by lever "Set Zero" "0-3" "0-300" easily coupled to rotary range switch by cord or lever. A gift at 20/-. Easily adjusted to 25-0-25 microamps.

RELAYS. As used in 1986, etc., series Aircraft Transmitters. Size: 1 1/2" x 1 1/2" x 3". 700 ohm coil, or 250 ohm coil. Operates on 12-24v. Double pole changeover. Price 3/6. Aerial Changeover Relays. 12-24v. operated 4 P.C.O. Price 3/6.

B.C.221 FREQUENCY METERS. In perfect condition, complete with original calibration chart, £16. Also a few soiled but in perfect working order, £10.

TYPE 46 TRANSCEIVERS. The best bargain for many years. These fine Walkie Talkies are now available in new condition, complete with all accessories at a give-away price. Three-Channel Crystal controlled T/X and R/X, supplied complete with one pair crystals, coil box, rod aerial, leads and plugs, valves, balanced armature headset with throat mike. 1 watt output. Coverage: 3.6-4.3 Mc/s. or 6.7-7.6 Mc/s. by means of Plug-in Coil Box. Inland buyers supplied with crystals in 3.5 or 7 Mc/s. band (state which required) other frequencies available for export. Requires only 150v., 15v., and 3v. dry battery. Range over 10 miles. Full instructions and circuit supplied. These units have been "demobbed" by removal of the "Send Receive" switch. A replacement switch with fitting instructions is supplied. We offer this fine unit with all accessories as listed above at the ridiculous price of 30/- or two for 57/6. Batteries are available at 24/- per set.

TIME SWITCHES. Type (2) Venner 14 day clockwork Time Switches. One make and one break every 24 hours. Complete with key, 5 amp. contacts. Price 32/6. Type (3) Mains Driven Time Switches. By first rate manufacturer. 200/250v. 50c. 10 amp. contacts, 45/-, Can be supplied with up to three "makes" and three "breaks" every 24 hours. Price with one pair of contacts. Each extra pair contacts, 4/-. Type (4) as above, but 20 amp. contacts. Price 69/6. Each extra pair contacts, 4/-.

I.F. TRANSFORMERS. Good quality iron-cored 465 Kc/s. Transformers. Type (1), size: 1" x 1" x 2". Price 2/6.

SILICON RECTIFIERS. Miniature silicon power diodes at new low prices. Made by one of England's greatest manufacturers. 250 mA. D/C output. Type (1) 400 P.I.V. Price 3/6. Type (4) 1,000 P.I.V. .45A. Price 8/6.

MODULATOR UNITS. Type (1) Ex the 1985 Aircraft T/X 7 watts Class B output. Crystal or low impedance input. Output matches TT15. Complete with valves 10/-.

FT.243 CRYSTALS. In addition to our standard range we now offer 3.5, 3.540, 4.590, 3.640, 3.680, 3.720, 3.760, 3.800 Mc/s., and 100 other types previously unobtainable between 3.840 and 6.450 Mc/s. All at 5/- each.

OSCILLOSCOPE TRANSFORMERS. A modern "C" Core Transformer, size only 3 1/2" x 3 1/2" x 4 1/2" high. Output 900v. 6 M/A. 300v. 100 M/A. 160v. 100 M/A. 6.3v. .6A, 6.3v. .5A twice, 6.3v. CT 1A, 28v. CT. .3A, Price 30/-.

MAINS TRANSFORMERS. Type (26) input 230v., output 250v. 60 mA. (H/W) and 80v., at .1A, 5/-, Type (16) 250v. 65 mA. (H/W) and 6.3v. 3A., 6/6. Type (350/120). 350-0-350v. 120 mA. 6.3v., 3.5A. 5v. at 2A, 16/6. Type (350/300) 350-0-350v. 300 mA. 6.3v., 8A., 5v. 2A., 4v. 2A. 6.3v. 2A. Price 27/6. Type (5K) 330-0-330v. 300 mA. 5v. 3A. tapped at 4v. 2v. 2A. 10kV. ins. 20v. 1A., 7.5v. 1A., 5kV. 5mA. Price 25/-.

"C" CORE TRANSFORMERS. 250-0-250v. 60 mA; 6.3v., 2 amp.; 6.3v., 3 amp.; 5v., 2 amp. Price 17/6. Type (OT9A) 500-0-500v., 180 mA, 5v., 3 amp.; 6.3v. 6 amp.; 6.3v., 3 amp. Price 35/-.

I.F. AMPLIFIER STRIPS. Three stage I.F. amplifier strips ex. the TR.1985/1986 series transmitters. Frequency 9.72 Mc/s. Widely used as an F.M. amplifier, etc. Price, complete with 6 valves, 10/-.

TOROIDAL CORES; 2" diam. 3/8" x 3/8", 3/6.

FERRO-CUBE LA2/type 25 pot cores, 5/-.

POT CORES. 3/8" diam., 3/8" thick, adjustable slugs, 1/6 each.

FT 243 CRYSTALS In addition to our standard range we now offer 3.5, 3.540, 3.590, 3.640, 3.680, 3.720, 3.760, 3.800 Mc/s., and 100 other types previously unobtainable between 3.840 and 6.450 Mc/s. All at 5/- each.

BC610 TUNING UNITS. These compact units (size: 9" x 4" x 2") were used as plug-in tuning boxes with the BC610 T/X. They contain miniature variable condensers of 140 pf and 100 pf, a standard size 50 pf ditto. A 1 1/2" dia. 0-100 graduated knob/dial, A DPDT toggle switch and several other components. Coverage is 6.35-8 Mc/s. Price 6/6 each.

CERAMIC WAVECHANGE SWITCHES. Type (1): Complete assembly as used in the AR.88. Price 8/6. 4-bank switches, each bank 2 poles 6 ways. Price 7/6. Type (3): 2 bank 1 pole 11 ways. Price 7/6.

CRYSTALS FOR REGRINDING. We offer high grade crystals in 10X holders within 50 kc/s. (lower) of your specified frequency at the bargain price of 6 for 10/-. Limits 2-8.5 Mc/s.

TRANSMITTER UNITS. The transmitter portion of the 1986. Unusable in its present form, but a useful basis for a 2 Metre T/X. Contains many useful parts including a 5 Gang Butterfly Condenser. Price 5/-, or with QV04/7 (Driver) and TT15 (15 watt input on 144 Mc/s. with 300v. plate) final. Price 27/6.

2 METRE R/X. Receiver portion of the SCR.522, less relay, new with valves and conversion details for continuous tuning 144-146 Mc/s. Price 30/-, or 37/6 with Relay.

R/X UNIT, TYPE R.114. An excellent basis for a 2 Metre Converter. See February S.W. Mag. Complete with valves and Jones plug and socket. Price 15/-, post paid. Extras if required, Crystal 5/-. I.F. Trans. as specified (unconverted) 2/6.

R.F. UNITS. Brand New RF25B units (30-40 Mc/s.) 17/6. Brand New RF27 (80-100 Mc/s.) 25/-.

DISC CERAMIC CONDENSERS. Available in .001, .005 and .01 mfd. 500 v.w., 4/- per dozen, your selection.

TERMS OF BUSINESS. All prices include postage or carriage within 200 miles. Handling charge of 1/6 on orders under 10/-. Payment cash or C.O.D. over £1. Export orders welcomed.

**INDEX TO
ADVERTISERS**

	PAGE
Anglin	668
Avo. Ltd.	617
Brookes Crystals	620
Cathodeon Crystals, Ltd. ...	667
Dale Electronics	<i>cover iii</i>
Daystrom	<i>cover iv</i>
G3HSC (Morse Records)... ..	672
G.W.M. Radio	671
Harris, P.	670
Home Radio	671
James Scott & Co., Ltd. <i>front cover</i>	
K.W. Electronics	624
Labgear	<i>cover ii</i>
Minimitter	669
Mosley Electronics	619
National Radio	620
Norman Birkett, Ltd.	669
Organs & Electronics	667
Peter Seymour	620
Rollet	672
Short Wave (Hull) Radio... ..	670
Small Advertisements	668-672
Smith & Co. (Radio) Ltd. ...	621
Southern Radio	620
Southern Radio & Elec.	672
S.W.M. Publications	618
Testgear Components. Ltd. ...	622
Tiger Radio, Ltd.	621
Whitaker	<i>cover ii</i>
Withers (Electronics)	668
Young	<i>cover iii</i>

SHORT WAVE MAGAZINE

Vol. XIX

FEBRUARY, 1962

No. 220

CONTENTS

	Page
Editorial	625
Modern Transmitter for 160 Metres, <i>by D. Pratt (G3KEP) and D. Noble (G3MAW)</i>	626
Five-Transistor Converter for Two Metres, <i>by B. J. P. Howlett (G3JAM)</i>	632
DX Commentary, <i>by L. H. Thomas, M.B.E. (G6QB)</i>	636
Aerial Hints, Tips and Ideas, Part II, <i>by The Old Timer...</i>	644
RTTY Topics, <i>by W. M. Brennan (G3CQE)</i>	647
RTTY and The SWL, <i>by J. B. Tuke (G3BST)</i>	650
Kitchen-Table Construction, <i>by W. Farrar, B.Sc. (G3ESP)</i>	652
VHF Bands, <i>by A. J. Devon</i>	654
Amateur Microwave Equipment, Part I, <i>by D. Clift (G3BAK)</i>	657
New QTH's...	661
The Other Man's Station — G3MAY	662
Another Man's Shambles — G3LSD	663
The Month with the Clubs — From Reports	664

Managing Editor : AUSTIN FORSYTH, O.B.E. (G6FO)

Advertisement Manager : M. GREENWOOD

*Published on the first Friday of each month at 55 Victoria Street,
London, S.W.1.*

Telephone : Abbey 5341/2

Annual Subscription : Home and Overseas 36s. (\$5.25 U.S.) post paid

© Short Wave Magazine Ltd.

AUTHORS' MSS

Articles submitted for Editorial consideration must be typed double-spaced with wide margins on one side only of quarto or foolscap sheets, with diagrams shown separately. Photographs should be clearly identified on the back. Payment is made for all material used, and it is a condition of acceptance that full copyright passes to the Short Wave Magazine, Ltd., on publication.

K. W. ELECTRONICS



THE DRAKE 2B RECEIVER (new from U.S.A. with a very high reputation)



Receiver complete with crystal calibrator and "Q" Multiplier/Speaker Unit, £138.
(Units available separately)

First and foremost — for your Amateur Radio requirements

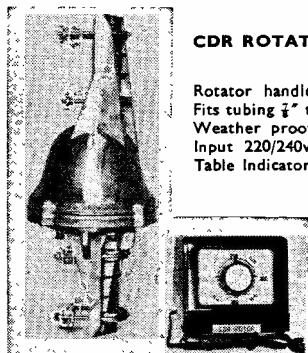

CDR ROTATORS (USA) AND CONTROL UNIT

Rotator handles a 150 lb. load with ease. Fits tubing 1/4" to 2" dia. Weighs only 10 lbs. Weather proof. Instantaneously reversible. Input 220/240v. A.C. Price: Rotator and Table Indicator. £18. 19. 0

PLEASE NOTE.
These Rotators are especially made for KW and do not require a mains step-down transformer.

K.W. QUALITY EQUIPMENT ★

KW equipment usually available from stock:—

- ★ **KW VANGUARD.** 50 watt Transmitter. A.M. and C.W.
- ★ **KW VICTOR.** 120 watt Transmitter. A.M. and C.W.
- ★ **KW VALIANT.** Mobile and fixed station. Tx.
- ★ **KW 160.** "Topband" Tx. High level mod and BK C.W. (Series II available).
- ★ **"KW Match"** SWR Meter. Low and high Pass Filters. Microphones. Dow-Key Relays, etc.

★ The KW "VICEROY" SSB TRANSMITTER — 180 watts P.E.P. input, 10-80 metres, crystal filter. Full Vox and anti-trip control. Full TVI precautions. (Now in use in over 30 countries.) Write for full details.

★ **THE KW "VICEROY" SSB EXCITER**
Very SUITABLE FOR DRIVING THE P.A. of your A.M. transmitter. It is not difficult to change your "Class C" stage to a linear. Similar in appearance to the KW "Viceroy" but with self contained power supply. 8 watts input sufficient to drive Linear 6146's, 6X4's, 4/125A, etc. Low impedance output. Full VOX control and anti-trip. £87. 10. 0 plus carriage

★ **THE KW500 LINEAR AMPLIFIER**
500 watt P.E.P. input, grounded grid P.A. Suitable for being driven by the KW "Viceroy" or similar transmitter. Including 1750 volt H.T. supply. £87. 10. 0 plus carriage

Main Distributors for



HAMMARLUND

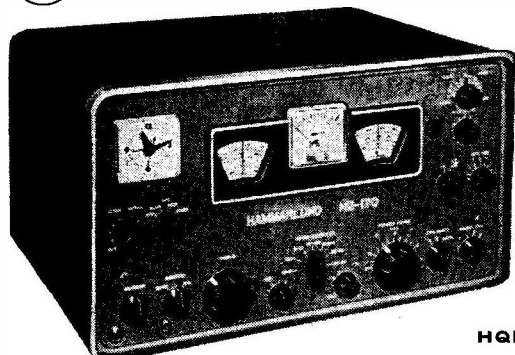

HQ170

HQ170. Triple Conversion, selectable sidebands, full bandwidth 6, 10, 15, 20, 40, 80 and 160 m. 17 tubes 100 kc crystal calibrator. Excellent performance, £184.
(Other models in stock including the latest HQ 100A & HQ 145X).

your NEW Communications Receiver

• hallicrafters •
(also HT 37 TX)

DRAKE • GELOSO • MOSLEY

(Model 2B) (G209-R) (CM-1)

Make sure you buy a new Receiver that is "peaked to perfection." Our engineers take a pride in adjusting all imported Receivers to meet manufacturers specification.

We believe we have the largest turnover of imported Amateur receivers in the U.K. Our stocks are always changing, therefore, you can be assured that you get the latest Production model.

We stock:—
MOSLEY. Beams and Vertical.
K.W. TRAP DIPOLES.
B & W PHASE-SHIFT NETWORKS, £2. 15. 0.
MCCOY 9 mc/s. FILTERS, £16. 10. 0.
Most available on easy terms.

Again Available:—

★ The famous **KW-GELOSO CONVERTER.** Remarkable Bandspread and Stability. Self-contained Power Supply, 4.6 mc/s. output. The "Rolls-Royce" of converters. Price £23 plus 10/- carriage.

EASY TERMS AVAILABLE

IMPORTERS OF U.S.A. EQUIPMENT

TRADE IN YOUR RECEIVER FOR A NEW ONE !

K.W. ELECTRONICS LTD., VANGUARD WORKS

1 HEATH STREET, DARTFORD, KENT.

Cables: KAYDUBLEW - Dartford.

Tel. Dartford 25574

The SHORT-WAVE Magazine

EDITORIAL

Safety *Familiarity with electrical apparatus, and the relatively high voltages used in our work, tends to make some of us a good deal less careful than we should be in handling our equipment.*

It is true that provided you know what you are doing, you can seem to go on getting away with a good deal. But the snag here is that you always have to remember what you are doing — there is no margin for error. Some people can stand, without serious discomfort, shocks which would kill others. At one end of the scale, there are people taking kicks from a 1,500-volt supply; at the other, there is a well-authenticated case of a man being killed, indirectly, through contact with a circuit at a potential of only 60 volts.

Fortunately, it is quite easy to take the proper precautions in and around our stations. The first thing is to provide a really good earth, and to arrange for earthing down aerials when necessary; the next is to see that all apparatus needing to be earthed is connected to a main earthing lead by heavy rubber-covered wire; thirdly, all AC wiring should be three pin, with N, L and E correctly connected throughout. Fourthly, all power packs should be permanently bled and correctly fused, and in HV packs the heater and high-voltage transformers should be interlocked in the switching. Fifthly, power packs should be stowed in such a way as to be inaccessible in operation, with all connections to them carefully insulated and fused. Sixthly, all power used in the station should be taken off one main double-pole on-off switch, so that in an emergency everything can be shut down (and all members of your household should know where this switch is). And finally, that golden rule — to make transmitter adjustments with one hand in your pocket when power is on — should be observed as a matter of habit.

At too many amateur stations, hair-raising risks are being taken without thought of the consequences — for family and friends. It is the duty of all AT station operators to make their equipment safe, and to keep it so.

*Austin Fobler
G6FO.*

WORLD-WIDE COMMUNICATION

Modern Transmitter For 160 Metres

INCORPORATING CRT
MONITOR — PHONE/CW/MCW
OPERATION — SELF-
CONTAINED FOR POWER

D. Pratt (G3KEP) and D. Noble (G3MAW)

With the trend of activity towards the LF bands, this design will be of great interest to those who like to build their own gear. Though intended to include the monitoring and MCW facilities, these may of course be omitted if preferred by suitable modification of the switching circuits. Indeed, the design as a whole incorporates sound basic circuitry for a Top Band transmitter to operate CW only, CW/Phone, or Phone only, with or without power supply built in.—Editor.

THE transmitter described in this article was designed to fulfil the requirements for a self-contained rig suitable for efficient working on the 160-metre amateur band. It was decided to replace the original installation with a more modern design, and to eliminate "external attachments."

The brief specification of the transmitter is as follows:

- (1) Clapp VFO — untuned buffer amplifier — RF amplifier with pi-tank circuit;
- (2) High quality anode-and-screen modulation with provision for "mixing" a second input of high level;
- (3) Internal 1000 c/s sinusoidal MCW oscillator for slow Morse transmissions and test purposes;
- (4) Internal 1in. cathode ray tube for modulation monitoring;
- (5) Built-in power supply.

It was also aimed to build the transmitter into as small a space as possible; it is in fact built into a cabinet identical in size to the popular TU unit outer case.

Due to the small size of the instrument and the consequent restricted space on the front panel, the number of controls is kept to a minimum. This is achieved by incorporating

rather complicated transmit/receive switching. In this way it is possible, for example, to eliminate special controls for the MCW oscillator, using one key jack only (non-shorting type) switched to the PA cathode on CW, and to the phase-shift oscillator on MCW/Phone.

RF Circuitry

The first two stages on the RF section are built into an Eddystone diecast box with an internal screen fitted as shown in the illustration.

The VFO stage is fed from a stabilised HT supply of 150 volts. It uses a triode-connected EF91 in a Clapp oscillator circuit with the anode at zero RF potential. The output is taken from the cathode *via* a low-value condenser C10 in order to eliminate "pulling." A trimmer condenser, C2, is provided across the main tuning, C1, so as to enable the VFO to be set up initially.

V3 is a conventional buffer amplifier which requires little comment. It is run at a fairly high power in order that a low value of coupling condenser may be used while still obtaining sufficient grid current to the PA valve.

Output from the BA is taken through C16 to a nylon feed-through in the side of the diecast box. Another feed-through is fitted on the main chassis in a position near the PA control grid pin; between these feed-throughs comes C17. This is in an accessible position and can be adjusted in order to obtain the correct drive conditions to the PA stage. It was found in the prototype that correct drive was obtained with 27 $\mu\mu\text{F}$, but this may require slight alteration for stray capacity and component tolerances. This is probably the most convenient place to state that the maker's recommended control grid conditions for the 5763 are 60 volts across a 22,000-ohm grid resistor. This corresponds to a grid current of about 2.7 mA.

The rest of the PA stage is conventional save for the keying and switching arrangements which are dealt with later under the appropriate headings.

The PA output circuit is a *pi*-network designed to match the transmitter into a $\frac{1}{2}$ -wave end-fed aerial. A co-axial socket is provided on the front panel, connected *via* a 1 $\mu\mu\text{F}$ condenser to the output for monitoring and harmonic check purposes.

The tank tuning condenser, C28, is a good quality ceramic insulated single gang 500 $\mu\mu\text{F}$ broadcast type, whereas the aerial loading condenser, C29, is a similar 2-gang with its sections connected in parallel so as to give a

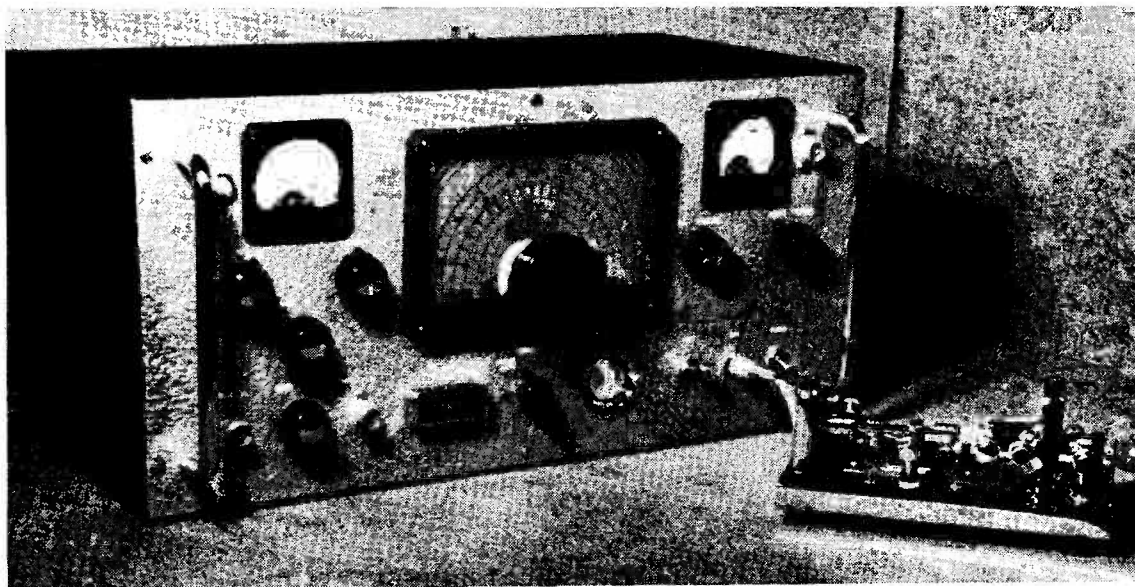

Front-panel view of the 160-metre transmitter described in the article, with a typical display visible on the screen of the 1-in. modulation monitor tube. The circuitry provides for CW, Phone and MCW operation, and the unit is self-contained for power. The main circuit diagram is shown in Fig. 1 and the power supply section in Fig. 1B.

total maximum capacity of $.001 \mu\text{F}$. Meters are provided to indicate the grid current and anode current of the PA stage.

TVI precautions include a parasitic stopper resistor, soldered directly to the anode tag of the PA valveholder, and heater decoupling condensers on all the RF valves.

Audio Circuitry

The modulator circuit is based upon the well-known Mullard "5-10" design, but negative feedback has been omitted. In addition, an ECC83 double triode is added. One triode of this provides the necessary microphone pre-amplification and the other acts as a low-level input stage feeding into the grid of the phase splitter. The tone control circuit is thus inoperative when the "B-input" is being used, and a separate gain control, VR2, is necessary.

For MCW purposes an internal 1000 c/s sine wave oscillator V5 is provided. This is coupled *via* a high value resistor, R24, to the "B-

input," and does not, therefore, have any adverse effects on any other input sources. VR1 enables the output of the oscillator to be adjusted to give the required modulation level with the external control (Gain B), VR2, at about half-track.

The 1000 c/s signal is obtainable at the "B-input" socket when the transmitter is switched to "receive," but this is of constant amplitude

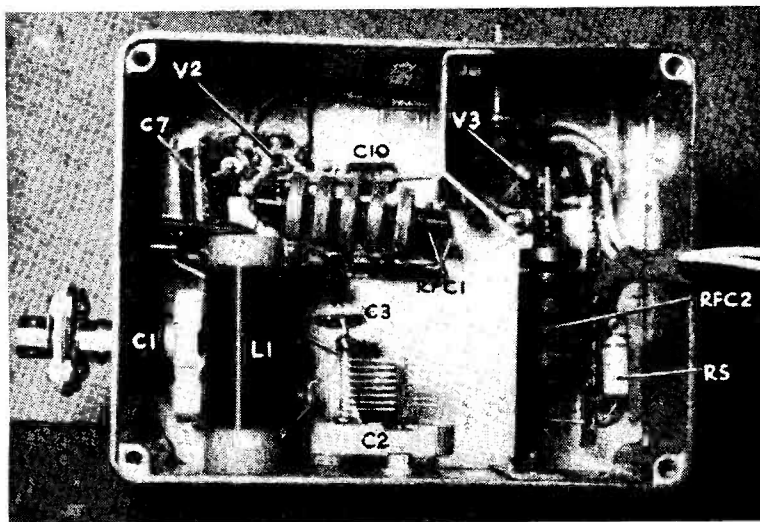

Inside view of the VFO compartment, an Eddystone diecast box, with the major items keyed — see circuit diagram Fig. 1. The screws which hold the lid also secure the unit to the main chassis.

Table of Values

Fig. 1. Circuit of the complete 160-metre Transmitter (See opposite)

C1 = 60 $\mu\mu\text{F}$ variable	C47 = 560 $\mu\mu\text{F}$, 5%, silvered-mica	R24, R30 = 2.2 megohms, $\frac{1}{2}$ watt, 10%	RFC1, RFC2, RFC3, RFC4 = 1.5 mH RF chokes (Eddystone 1022)
C2 = 60 $\mu\mu\text{F}$ preset variable	C48 = 8,200 $\mu\mu\text{F}$, 5%, silvered-mica	R25, R29 = 2,700 ohms, $\frac{1}{2}$ watt, 10%	CH1 = 2H, 300mA choke (T.V. smoothing choke)
C3 = 120 $\mu\mu\text{F}$, 10%, silvered-mica	C49 = 2,200 $\mu\mu\text{F}$, 5%, silvered-mica	R27, R28 = 220,000 ohms, $\frac{1}{2}$ watt, 10%	CH2 = 10H, 60mA choke
C4, C5, C21, C26 = 1,000 $\mu\mu\text{F}$, 10%, silvered-mica	C50 = 0.02 μF , 150v. wkg. paper	R33 = 6,800 ohms, $\frac{1}{2}$ watt, 10%	T1 = Woden Modulation transformer Type UM-0
C6, C16 = 100 $\mu\mu\text{F}$, 10%, silvered-mica	C53 = 330 $\mu\mu\text{F}$, 10%, silvered-mica	R34, R41 = 68,000 ohms, $\frac{1}{2}$ watt, 10%	T2 = Mains transformer 300-0-300 v. 150mA; 6.3v., 5A; 6.3v. 1A. (Gilson type W0741B)
C7, C11, C12, C15, C31, C39, C46, C51 = 0.01 μF , 400v. wkg. paper	C55 = 100 μF , 12v. wkg. electrolytic	R35 = 10,000 ohms, $\frac{1}{2}$ watt, 10%	L1 = 90 turns, 30 swg close-wound on a $\frac{1}{8}$ in. diam. former
C8, C9, C13, C14, C18, C19, C23, C24, C25 = 1,000 $\mu\mu\text{F}$, disc ceramic	C60, C61 = 50 μF , 25v. wkg. electrolytic	R36 = 1,800 ohms, $\frac{1}{2}$ watt, 10%	L2 = 60 turns, 24 swg close-wound on a $\frac{1}{8}$ in. dia. former
C10 = 12 $\mu\mu\text{F}$, 10%, silvered-mica	C62 + C63 = 32 + 32 μF , 500v. wkg. electrolytic	R37 = 120,000 ohms, $\frac{1}{2}$ watt, 10%	V1 = 150B2
C17 = 27 $\mu\mu\text{F}$, 10%, silvered-mica	R1, R15, R16, R17 = 100,000 ohms, $\frac{1}{2}$ watt, 10%	R38 = 470,000 ohms, $\frac{1}{2}$ watt, 10%	V2 = EF91
C20 = 16 μF , 450v. wkg. electrolytic	R2 = 7,500 ohms, 5 watts, 5% wire-wound	R39 = 150,000 ohms, $\frac{1}{2}$ watt, 10%	V3 = EL91
C22 = 1 μF , 500v. wkg. electrolytic	R3, R26, R31 = 47,000 ohms, $\frac{1}{2}$ watt, 10%	R40 = 33,000 ohms, $\frac{1}{2}$ watt, 10%	V4 = 5763
C27 = 1 μF , 500v. wkg. electrolytic	R4 = 150 ohms, $\frac{1}{2}$ watt, 10%	R42 = 1 megohm, $\frac{1}{2}$ watt, 10%	V5 = EF184
C28 = 0.002 μF , 1,000v. silvered-mica	R5 = 4,700 ohms, 2 watts, 10%	R43, R44 = 100,000 ohms, $\frac{1}{2}$ watt, 10%**	V6, V8 = ECC83
C29 = 500 $\mu\mu\text{F}$ variable broadcast type variable. (Both sections in parallel)	R6 = 22,000 ohms, 1 watt, 10%	R45, R46 = 820,000 ohms, $\frac{1}{2}$ watt, 10%**	V7 = EF86
C30 = 1 $\mu\mu\text{F}$ ceramic	R7 = 22,000 ohms, $\frac{1}{2}$ watt, 10%	R49, R50 = 270 ohms, 3 watts, 5%	V9, V10 = EL84
C32, C37, C58, C59 = 0.1 μF , 400v. wkg. paper	R8 = 10,000 ohms, 2 watts, 10%	R47, R48 = 4,700 ohms, $\frac{1}{2}$ watt, 20%	V11 = EZ81
C33, C43, C44 = 25 μF , 25v. wkg. electrolytic	R9 = 270 ohms, $\frac{1}{2}$ watt, 10%	VR1 = 300,000 ohms linear preset pot.	VRT1 = DH3-91 (1CP1)
C34, C35, C36, C37 = 500 $\mu\mu\text{F}$, 300v. wkg. paper	R10, R51, R52 = 47 ohms, $\frac{1}{2}$ watt, 20%	VR2 = 500,000 ohms log. pot.	PL1 = Panel lamp — 6.5v., 0.3A (Bulgin type (D180))
C38, C54 = 0.05 μF , 500v. wkg. paper	R11, R12 = 1,000 ohms, $\frac{1}{2}$ watt, 20%	VR3, VR4 VR5 = 250,000 ohms log. pot.	PL2 = Indicator lamp — two 6.5v., 0.3A bulbs in series. (Bulgin type D720/ Green/ legend)
C40 = 12.5 $\mu\mu\text{F}$ ceramic — see text	R13 = 18,000 ohms, $\frac{1}{2}$ watt, 10%	S1 = 3-way, 9-pole rotary switch (3 banks, 3 poles per bank)	J1 = Open circuit key jack (Bulgin type J2)
C41 = 1 μF , 300v. wkg. paper	R14, R32 = 39,000 ohms, $\frac{1}{2}$ watt, 10%	S2 = SPDT toggle switch (biased — see text) (N.S.F. type 8373/B4)	P1 = Mains input plug (Bulgin type P360)
C42, C45, C52, C56 = 8 μF , 350v. wkg. electrolytic	R18 = 820,000 ohms, $\frac{1}{2}$ watt, 10%	S3 = DFD T toggle switch (N.S.F. type 8370/K7)	
	R19 = 56,000 ohms, $\frac{1}{2}$ watt, 10%	M1 = 0-5mA, 2in. meter	
	R20, R21 = 3.3 megohms, $\frac{1}{2}$ watt, 10%	M2 = 0-50 mA, 2 in.	
	R22 = 470,000 ohms, $\frac{1}{2}$ watt, 10%		
	R23 = 120,000 ohms, $\frac{1}{2}$ watt, 10%		

* High Stability
** Matched to within 5%

and is not affected by the position of the external control. This output is very useful as an auxiliary source for providing a pure sine wave when required.

On "receive," HT is applied to the pre-amplifier stages in order that there shall be no delay when switching on the transmitter to telephony due to the finite charging time of the modulator decoupling circuits. However, the push-pull output stage supply is only applied when the transmitter is switched to telephony, as this delay effect does not occur, and modulation can thus be obtained instantaneously upon switching on.

The modulation transformer is a Woden UMØ and the figures in the circuit diagram

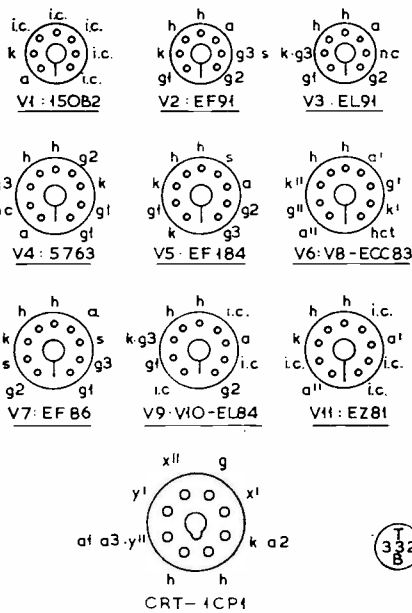

Fig. 1A, Base diagrams for the valves used in the 160-metre transmitter by G3KEP/G3MAW.

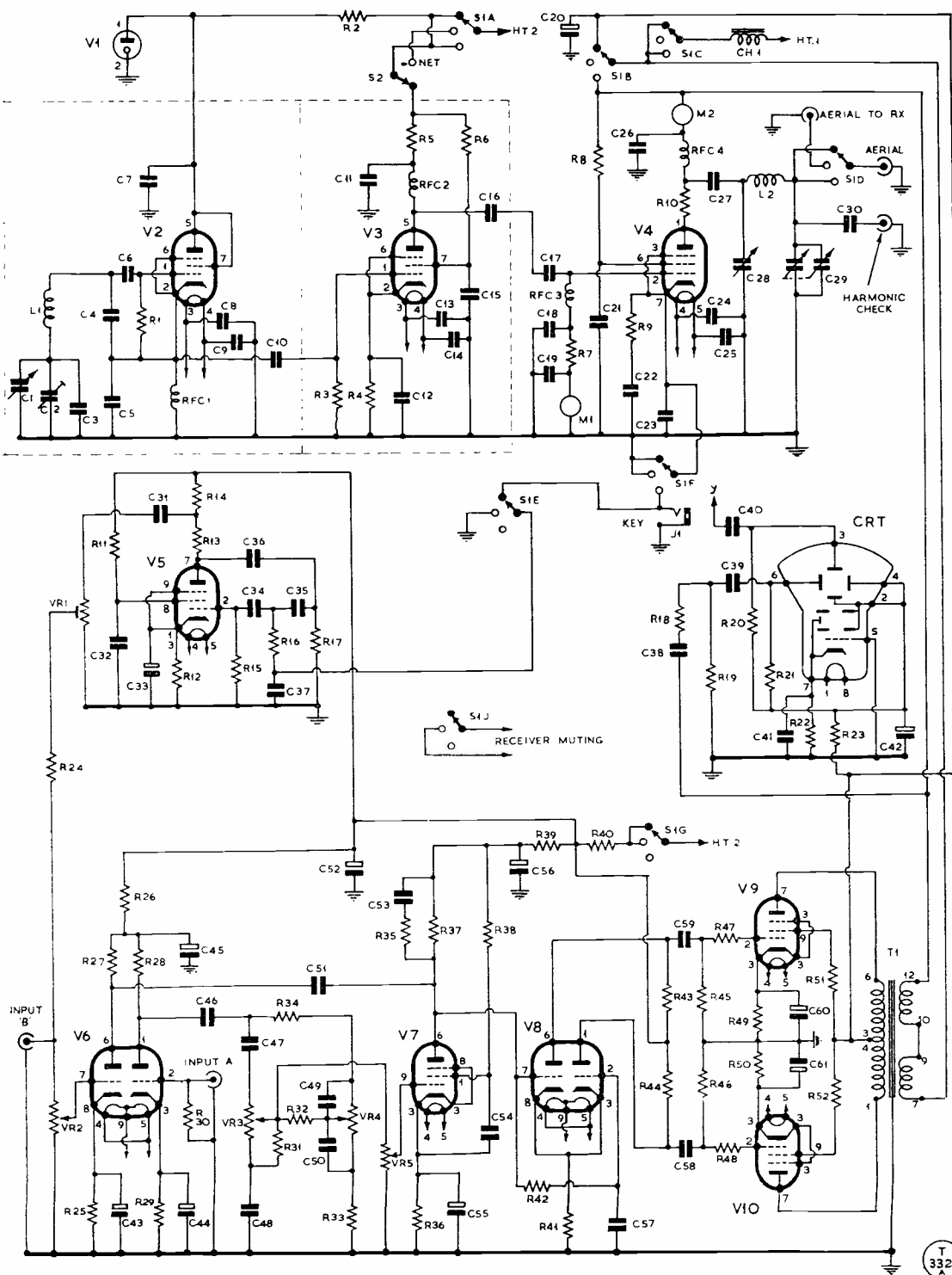

Fig. 1. Circuit diagram of the Top Band transmitter, fully described in the accompanying article. The power unit, integral with the transmitter in the model as illustrated, is at Fig. 1B, p.630.

correspond to the tag connections recommended to obtain efficient matching in the transmitter circuit described.

"Input-A" is intended for use with a high-impedance crystal microphone. It can, however, be used with a good quality dynamic microphone.

Monitoring Facilities

A 1-in. cathode ray tube is provided for modulation level monitoring. It operates with a very low final anode voltage which may be readily obtained from the normal HT rail to the modulator output stage. The modulation monitor is thus only operative when using telephony or MCW. A trapezoidal display is obtained by feeding a small audio voltage to the X-plates and RF to the Y-plates, in the normal way.

The RF deflection voltage is obtained by wrapping the connection from C40 round the PA anode lead to form a very small capacity. This may then be adjusted to give a suitable Y-amplitude. It is advisable that this adjustment be carried out with the transmitter connected to an aerial and tuned up. This is because the RF voltage present at the anode, and hence the deflection voltage, will vary con-

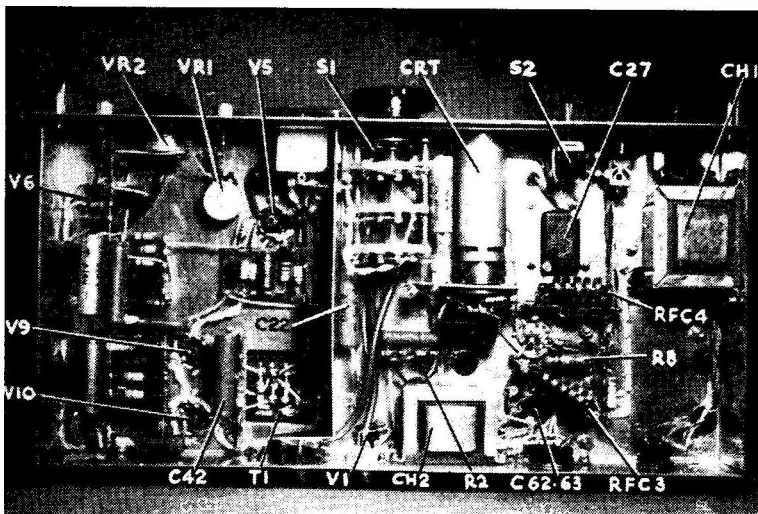

View under-chassis of the 160-metre transmitter described in the article, with key to layout (see circuit Fig. 1). The main control switch is at centre, with the speech circuitry to the left, and the PA and power supply sections at right, behind the modulation indicator.

siderably with load conditions. The X-deflection amplitude should be suitable with the circuit values given but, if necessary, may be adjusted by altering the ratio of R18 and R19 which are in a potential divider circuit.

So as to eliminate distortion of the display by stray pick up from heater wiring etc., an M.E.A. mumetal shield type ST.39 was used. (A suitable shield may readily be made from the screen from an ex-Govt. unit using a VCR97, for example.) Care should be exercised in working with the material in order not to disturb its excellent screening properties.

Switching

There are three switches in the unit:—(i) Mains supply switch; (ii) the netting switch; and (iii) the main transmit/receive switch, S1.

The transmit/receive switch has three positions. The central position is "receive" and the other two are for CW and Phone CW. Section "a" of this switch is used to switch the power to the VFO and buffer stages. A spring-loaded toggle switch is used for netting purposes, so that the VFO only comes up on "net." If the "net" switch is inadvertently left on when the transmitter is switched to "transmit," the buffer stage would not operate and the consequent lack of grid drive would result in the PA stage drawing excessive anode current which would cause damage. It is for this reason that a spring biased switch is used for netting.

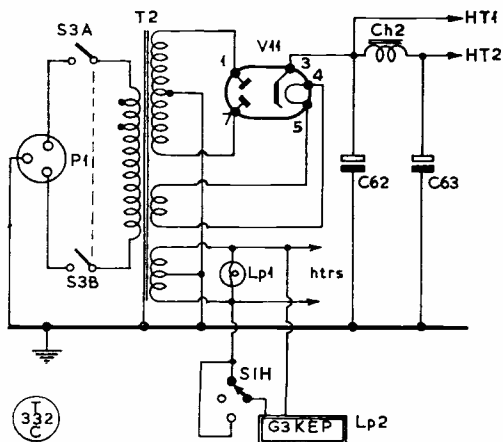

Fig. 1B. Power supply circuit for the transmitter, and included on the same chassis. Values given on p.628.

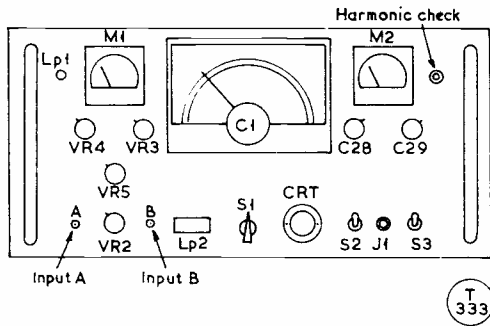

Fig. 2. Sketch showing front-panel layout in the model as illustrated.

Sections "b" and "c" of the transmit/receive switch are used on CW to feed the PA via the key click filter choke, CH1, from the main HT line. (The unorthodox position of CH1 will be explained later.) On telephony, these switches connect a 16 μ F condenser, C20, which gives additional smoothing together with CH1; they also feed the PA via the modulation transformer secondary and supply power to the modulator output stage and cathode ray tube.

S1d is the aerial change-over switch, while S1e and S1f are for keying; the modulator pre-amplifier stages and MCW oscillator HT is switched by S1g. S1j is for receiver muting and its connections are brought out through the octal socket at the rear of the chassis.

A panel light, PL2 (which in the case of the model reveals the call-sign of the station), is fitted, and is switched to the heater supply via S1h when the transmitter is operating.

Keying

As mentioned earlier, there is only one key jack for both CW and MCW. When using CW, S1f open-circuits the cathode of the PA valve and connects it to the key jack; S1e performs a similar function for the keying point of the MCW oscillator. The grid of V5 is keyed for MCW and as this is a low-current point, only a small condenser, C37, is required for click elimination. It is advisable that the key lead be kept as short as possible because of the AF present

under key-up conditions.

A current of up to 50 mA is to be expected in the cathode circuit of the PA. Thus, when using CW a more elaborate key-click circuit is required; R9 and C22 form part of the filter, while the key-click filter choke is in the HT line to the PA. The effect of the choke is to delay the current increase when the key is depressed, so controlling the click on "make." It is immaterial whether this be placed in the positive or the negative supply line to the PA valve. However, the effect of its DC resistance if placed in the cathode circuit results in the stage running at lower efficiency. It is for this reason, therefore, that the choke is shown in the PA anode-and-screen feed.

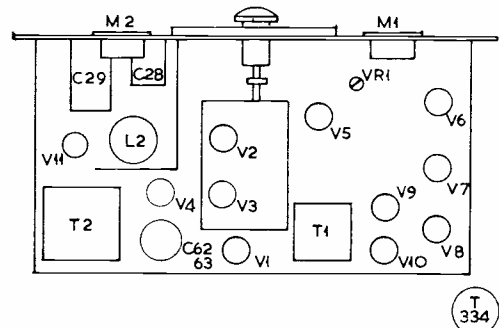
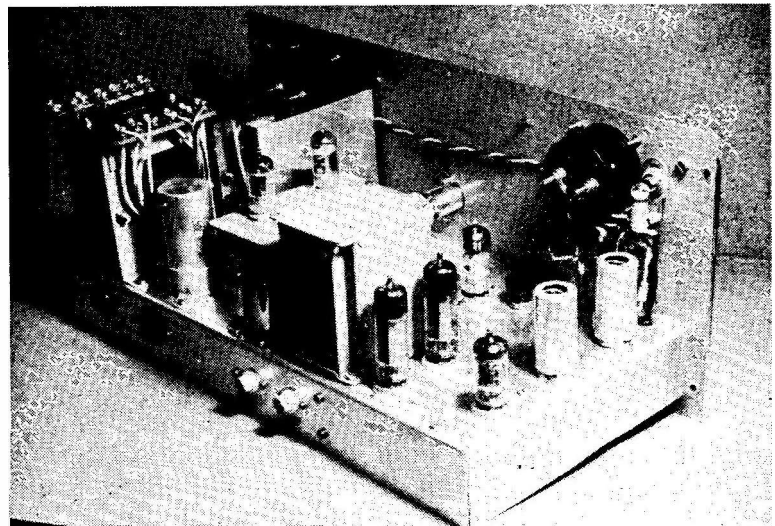

Fig. 3. Over-chassis layout for the major components — read with Fig. 2, and see photographs.



Three-quarter rear view of the Top Band transmitter, showing the AF section in the foreground. The screened-off PA compartment is at upper left. Along the rear chassis drop are the mains input, receiver muting, and aerial input and output connectors.

Power Supply

This is a conventional full wave HT circuit. The transformer used should be capable of giving 150 mA for HT, and 5 amps. for heaters, with an additional one-amp. winding for the rectifier valve V11. The HT smoothing consists of a dual 32 μ F, 500v. electrolytic as reservoir and smoothing condensers; a smoothing choke is connected with these in the normal low-pass filter circuit. HT1, which supplies the modulator output stage and PA stage, is taken direct from the anode of the reservoir condenser, while the supplies for the remaining lower level stages are taken from the better smoothed voltage across C63.

Appearance Considerations

The appearance of the finished transmitter was intended to be up to the standard of com-

mercially available amateur equipment.

A silver-hammered sprayed front panel contrasts with a black crackle cabinet, and by careful layout design a highly symmetrical front panel arrangement was achieved. The layout is dominated by an Eddystone full vision dial flanked by a pair of 2-in. meters.

Chromium plated fittings are used where possible, the cathode ray tube surround being a Bulgin type E.7 escutcheon intended for use with 1-in. magic eyes. The control knobs used are Bulgin type K.424/Chr. with chromium plated decorative inset discs.

Belling-Lee co-axial sockets serve as audio inlets; N.S.F. switches are used for mains and "net," with a Bulgin chromium plated jack socket for the key. The panel fittings are completed by two chrome handles so as to facilitate easy withdrawal from the cabinet.

Five-Transistor Converter for Two Metres

GIVING 35 dB OVERALL
GAIN

B. J. P. HOWLETT (G3JAM)

This is another offering for those who wish to experiment in the field of transistors on VHF. Our contributor has produced a practical design which will give excellent results on two metres with any receiver tunable over the range 1.7 to 3.7 mc. A transistorised converter of this sort has obvious advantages for those interested in VHF mobile, because it could be run from the vehicle 12v. battery line; if the car radio has "trawler band" tuning coverage, the receiving problem for a two-metre M installation is solved.—Editor.

SOME readers may have noticed in the December 1961 issue a short article describing a two-metre Converter using only two—or, with IF stage, three—transistors, and producing a 2.4 mc intermediate frequency range for the main station receiver by a single frequency change. It can now be said that a

parallel line of investigation led to the development of a five-transistor converter using double frequency change, coming out at an IF of 1.7 to 3.7 mc tunable on the main receiver.

Several crystal oscillator multiplier chains have been employed by the writer in previous (valve) converters using different harmonics of the same crystal for the two frequency changers with satisfactory results; but there can be snags in this, and it will not be out of place to examine these oscillator arrangements and see what they are.

Harmonic Selection

A converter is still being used which has a fundamental crystal oscillator of 7.5 mc and this employs a double-triode, grids and cathodes strapped, but with each anode tuned to a different harmonic. The first anode produces 30 mc and this is doubled twice in another double-triode to provide a main heterodyne injection of 120 mc. From the signal frequency band of 144-146 mc, therefore, a first IF of 24-26 mc is produced: so far quite normal.

However, when this is re-mixed with the 22.5 mc coming from the other anode of the crystal oscillator, a second IF of 1.5-3.5 mc appears, and it is this which is passed to the main receiver, enabling excellent stability and bandwidth to be obtained even on an ancient CR-100.

The snag (fortunately more imagined than real) lies in there being a weak oscillator harmonic at 90 mc, which, if it is allowed to, can pull in stations in the Band II Broadcast

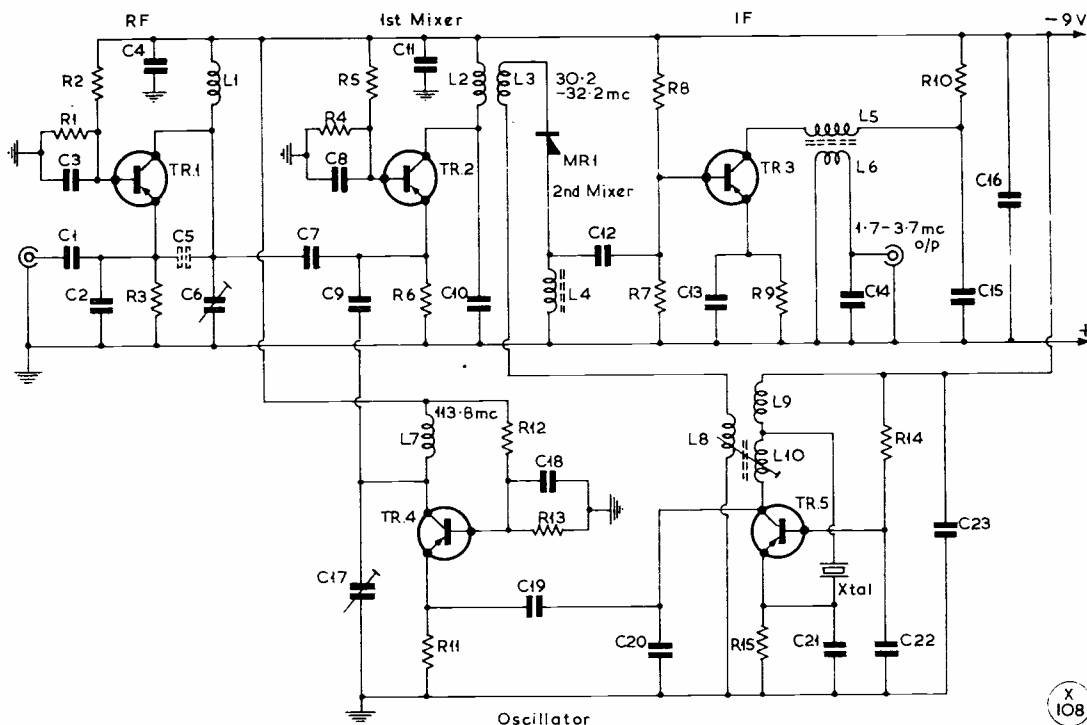

Fig. 1. Circuit complete of the five-transistor two-metre double-conversion receiver unit designed and described by G3JAM. The final IF is at 1.7-3.7 mc, covered by most receivers in use on the amateur bands. All values are given in the table and a full-size layout sketch at Fig. 2.

and Police allocation.

Similarly, an 11.875 mc crystal, overtuned at 35.625 mc, trebled to 106.875 mc, can produce IF's of 37.125-39.125 mc and 1.5-3.5 mc, with a slight chance of Police pick-up.

The crystal chosen for the converter described here — see Fig. 1 — is 9487.5 kc oscillating at (almost) 28.5 mc in the grounded base overtone oscillator TR5, the frequency being quadrupled in TR4, also grounded base, and passed into the grounded base first mixer TR2. Emitter injection through small capacitors for both oscillator and signal is used and was found to give the most reliable results. (Actually, it was while studying the action of this part of the circuit that the writer got diverted on to the self oscillator-mixer described in December, thus delaying matters somewhat !)

Circuit Points

Ignoring the fact, also, that the converter started life with a fully tuned grounded base RF stage, (it was eventually discovered that the aerial tuning was hampering development rather than otherwise), we therefore now have an untuned input to the emitter and perform-

Table of Values

Fig. 1. Circuit of the 35 dB VHF Converter

C1 = 18 μ F, ceramic	C23 = .0039 μ F, ceramic
C2 = 9 μ F, ceramic	R1 = 3,900 ohms
C3, C8, C18 = .001 μ F, ceramic	R2, R4, R6, R7, R13 = 10,000 ohms
C4, C11 = .001 μ F, pillar cer.	R3, R9, R10 = 1,000 ohms
C5 = see text	R5 = 15,000 ohms
C6 = 2-10 μ F, var.	R8, R12 = 33,000 ohms
C7, C9 = 4.7 μ F, cer.	R11 = 1,500 ohms
C10, C20 = 20 μ F, cer.	R14 = 560,000 ohms
C12, C14, C22 = .002 μ F, cer.	R15 = 470 ohms
C13 = .01 μ F, ceramic	TR1 = 2N1742
C15 = .01 μ F, tub.	TR2 = OC171
C16 = .005 μ F, tub.	TR3 = AF117
C17 = 30 μ F Philips trimmer	TR5 = Diode, low-imp.
C19 = 8 μ F, ceramic	
C21 = 40 μ F, ceramic	

COIL DATA TABLE

- L1 — 2½ turns 18g. enam., ⅞-in. internal diam., self-supporting
- L2 — 22 turns 22g. enam., ¼-in. internal diam., self-supporting checked to resonate at 34 mc with C10.
- L3 — 6 turns 22g. p.v.c., over-wound on L2.
- L4, L5 — 70 turns 40g. enam., flat-wound on aerial ferrite, ¼-in. diam. by ¼-in. long.
- L6 — 8 turns 32g. enam., wound over L5.
- L7 — 2½ turns, 18g. enam., self-supporting, ⅞-in. internal diam., turns slightly spaced.
- L8 — 5 turns, 22g. p.v.c., over cold end L10.
- L9 — 4½ turns, 22g. p.v.c., close-wound and self-supporting, ¼-in. internal diam.
- L10 — 9 turns, 22g. enam., close-wound on ¼-in. former with dust slug.

Crystal — Brookes Type G, B7G glass envelope, 9487.5 kc. (Calibration temp. 20° C; shunt capacity 30 μ F).

(Note: When preparing to wind L4, L5, L6, fix on 22g. bare wire ends with sticky tape; these ends then act as connectors.)



ance control by feedback *via* C5 which, with a 2N1742, is so small as to be almost non-existent! With other transistors graded in order of *alpha* cut-off (for instance Mullard AF102, AF114, OC171, AF115, OC170, AF116, AF117 in approximately that order—however all “drift” types), C5 must be made progressively larger, but in no case will it exceed 3 $\mu\mu\text{F}$. There is a limiting value in all cases when the stage breaks into oscillation; a pair of twisted wires is all that is needed—even these almost disappearing with the 2N1742 and AF102 types.

The mixer needs little comment, save in saying that the values chosen will enable the first five Mullard types mentioned to work satisfactorily.

Passing on from the mixer, the attentive reader will by now have worked out the fact that, since the first local oscillator injection frequency is 113.8 mc (allowing for the overtone effect on the frequency of oscillation) therefore the first IF must be 30.2-32.2 mc, coupled into the diode mixer MR1 *via* the matching transformer L2/L3 tuned by C10 (20 $\mu\mu\text{F}$). The lower end of L3 connects to the first oscillator coil, round which it is wound, appearing in the circuit as L8/L9. The diode DC return is through L4, little better than a RF choke.

The 2nd IF, produced in the diode is 1.7-3.7 mc and feeds into the grounded emitter IF stage TR3 which, because its collector circuit is very flat tuned (L5/L6) requires no neutralising. The condenser C14, across L6, is not there for tuning purposes but for filtering. (The writer has been in the habit of using this converter with a transistor back-end having no RF stage and until this condenser was included considerable oscillator “blowback” was experienced.)

In fairness, it must be stated that all the development work was done and field trials carried out using types AF114 and AF102 in the RF stage, and measurements were also made using OC170, OC171, and AF117. The results obtained agreed closely with the published performance data on these types, but it must be said that an improvement in noise factor was observed with the less exotic ones if run at a higher current, by, for example, reducing R2. However, in fairness to our American friends, it must also be stated that their best transistors are just measurably superior even if the difference is not very noticeable on an actual listening test.

In passing, the writer would like to make a few comments on one or two points which

could arise in discussion:

- (1) Why, when the noise factor of a 2N1742 has been shown to be most stable with a 12v. supply have we used 9 volts?
This has been done to enable Mobileers to employ zener diode stabilisation from their nominal 12-volt supply.
- (2) How can I fit a gain control?
Make R1 a variable, taking the base of TR1 to the slider.
- (3) Can I use an FT243 crystal instead of an evacuated type?
Why spoil the ship . . . !
- (4) With an untuned input from the aerial, and with the 70 cm. beam right through the middle of the 2-metre six-over-six, would it be safe to work full duplex?
OK, Boy, you made your point!

The writer would suggest that this last point be fully investigated in each individual case: it is certainly a serious matter, not confined to duplex working. The writer admits to using a modified signal generator attenuator block as a T/R switch, and the isolation between contacts is probably about 120 dB, but a bad, so-called, coaxial relay (or a sticky one) could wreak untold mischief.

Performance is, briefly: 35 dB gain with an overload level of 400 millivolts output into 75 ohms. Noise factor as follows (manufacturers' figures): 2N1742, 5 dB; AF102, 6 dB. Also measured: AF114, 9 dB; AF117, 15 dB. The AF117 is unsuitable for VHF, but the writer would add that it is not through any lack of gain, surprisingly enough!

The gain at the band edges is -6 dB relative to the centre, noise factor unaffected, and the concealed image response, 138.6-140.6 mc, is about -17 dB and has given no trouble.

Current consumption could be given individually, but the practice is often unnecessary in transistor circuits since a quick calculation from the resistor values shown is all that is needed for a first approximation to be made. Assuming that the emitter voltage is within $\frac{1}{4}$ v. of the base voltage (and this is a very accurate assumption in most cases) have a look at the base bias potentiometer ratio: this will give the portion of applied battery volts on the base, and hence the emitter. This value of voltage divided by the emitter series resistor, therefore, gives the current, to a first approximation, and for TR1 in this circuit is seen to be about $2\frac{1}{2}$ mA; this will remain true whichever transistor is used. The mixer TR2 can be expected to draw $\frac{1}{4}$ mA, and the IF stage 2 mA; the various supply potential

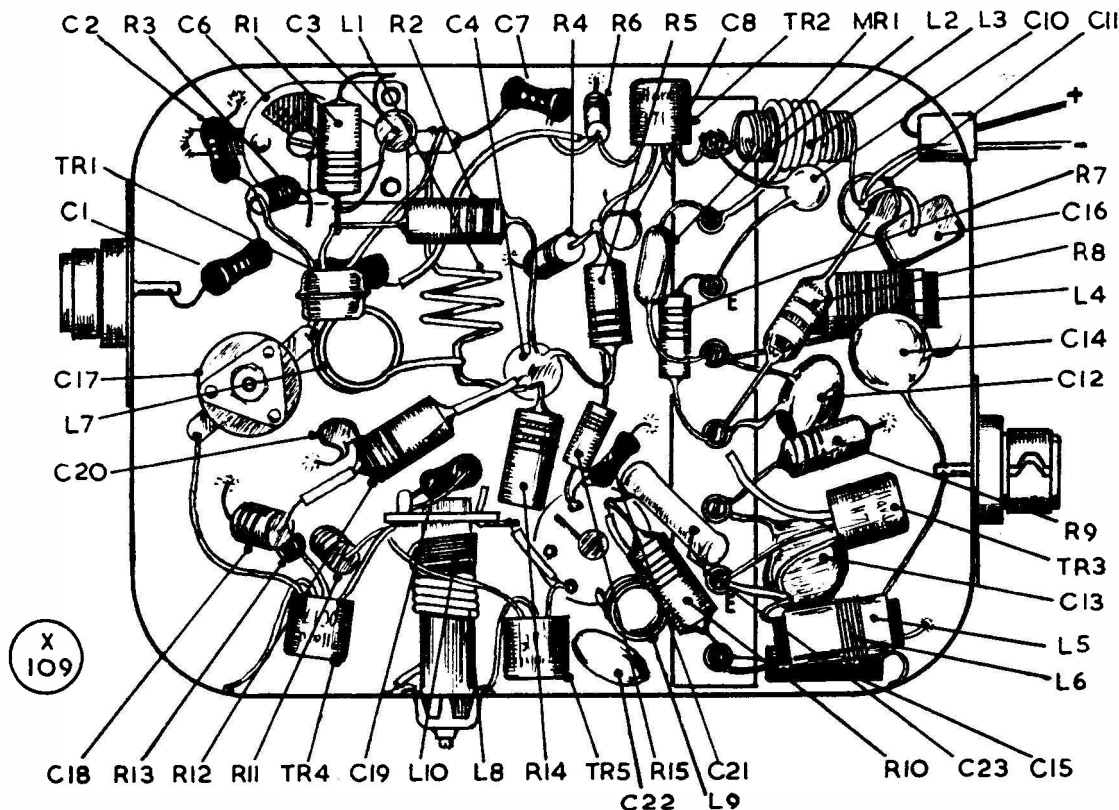

Fig. 2. Construction of the five-transistor two-metre converter as adopted by G3JAM. This drawing is to full size, and can be followed exactly as shown here. As suggested in the text, other constructional layouts are possible and may in some circumstances be more convenient.

dividers account for $1\frac{1}{2}$ mA, and the total current consumption is about 9 mA, so that leaves 2.75 mA to be shared between the two oscillator transistors, TR4 and TR5; as might be expected, they vary a little dependent on strength of oscillation.

Construction

As to putting the thing together, it is suggested that it be on the same lines as before—p.515, December, 1961, *Short Wave Magazine* and at Fig. 2 is shown an actual-size sketch of the prototype as built up by the writer, and on which this article is based. The experienced VHF constructor will have no difficulty with this, even if final adjustments are a bit tricky.

The not-so-experienced may prefer to use a more conventional layout form—but it must be emphasised that the circuit sequence has to be followed in the physical sense, with the shortest possible leads. Probably, the best constructional approach is to consider the circuit as three separate elements—oscillator section, which could be put together as one unit on a

small insulating strip; RF and first mixer section on another; and diode 2nd mixer and IF stage as the third unit. With these sections fitted together into a box chassis about 6 ins. long by 3 ins. wide and an inch or so deep, a symmetrical layout—RF, oscillator, and IF unit, in that order—could be achieved, with room to get at each section for adjustment.

And so to conclude, with acknowledgements to Mullards for their assistance and advice; to G3KMP and the Hastings Group, who put up with the writer for nearly 24 hours; to G3IMC, who facilitated a battery-operated mobile test; and to G3LJB, for the /P exploit on the top of Dunstable Downs.

INDEX TO VOL. XIX

With the forthcoming (March) issue of *SHORT WAVE MAGAZINE* we start yet another Volume, the 20th, as the present offering concludes Vol. XIX. Therefore, every copy of the March issue will contain, as a free loose supplement, a detailed Index to the volume now closing.

DX COMMENTARY

L. H. THOMAS, M.B.E. (G6QB)

THIS month's offering may prove to be a bit of a disappointment to many readers who have written in with their usual comments, news items and details of DX worked. But unfortunately (owing to circumstances over which we have no control, as is said everywhere nowadays) their letters had not arrived by the deadline and were doubtless languishing on some bleak station platform, buried under hundreds of other mail-bags.

Most frustrating and discouraging, but they will doubtless arrive in time for next month's offering; and meanwhile we must organise this one as best we can from all the information received from other sources. After all, variety is the spice of life (as someone once laughingly observed); and for once in a while this feature will have to depart from its normal make-up.

The one bright spot is that, whatever has been happening to other forms of communication, our own special preference has gone along much as usual. The DX bands have been quite good; the activity level (and the QRM) has been quite high; and there is every sign that the coming spring will be quite a good DX season.

From *Fifteen to One-Sixty* (we can hardly include *Ten* this time) there have been plenty of interesting goings-on, and if the reporting of them this month has a strong overseas flavour, perhaps it is none the worse for that. Normally we have to condense the DX news from overseas sources in order to make room for U.K. readers' comments; this month there is no such restriction.



ZB1RM

CALLS HEARD, WORKED and QSL'd

Trans-Atlantic SSB, One-Sixty

Last month, as it happened, we hardly commented on the Top Band DX work at all, no particular news having come to hand. This time, it seems, everything has come in at once. Pride of place must certainly go to the achievement of G3CHN (Kingsbridge), on December 22. On that morning, at 0042 GMT, he was in contact with W2FYT, and at 0045 they both wound their carriers out and made the "first" for which they had been waiting and hoping—two-way SSB! W2FYT was R5, S3-7, and G3CHN was R3-5, peaking S6. They exchanged all the necessary information and then reverted to CW. This is believed to be (and almost certainly is) the first Trans-Atlantic two-way SSB on One-Sixty. Very fine business, and congratulations to the operators at both ends.

G3CHN has not figured in these columns much before, but Roger has been plugging away this season with great success; he first

worked W2FYT at 2340 GMT on November 27, and it was then that they agreed to try for the phone QSO. On December 11-12 he raised K1KSH, W3FBV, W8UDN, W1FRR, W1BB, W2UWT, W2NVD and W2UWD, in that order, between 2325 and 0220 GMT. Many others were heard—all CW, of course. The second official test on December 17 brought contacts with W1BB/1 and W1HKK, whose SSB was R4 and S6, but they didn't try to make it two-way during a test.

Roger concludes: "You may imagine how thrilled we both are about this. Without Tony's tremendous patience, I am sure it would never have happened. I am also well aware of the unique position here as regards site, aerial and huge earth mat. Not least, the chaps this side have been wonderful, letting me hog 1801-1805 kc for long periods."

(Late note: G3FPQ reports working W1HKK, two-way SSB, on January 8, and says that

G3CHN also worked him on that occasion.)

Top-Band DX

G5JU (Birmingham) worked W8JIN and W1PPN on December 17, and heard W1BB/1 and W8FW. This was said to be W8JIN's first European QSO; on the same night Jerry reports that W2GGL worked G3PU, G6BQ and GD3UB, and that W8FW and W8JIN were both heard working G3ERN at the same time!

G3OQT (Romford) must be the first G3... to get across on Top Band. He did it, too, on December 17, raising W1PPN at 0750 GMT (559/339). He had been at it since 0300 and was on the point of giving up, but then had that contact in broad daylight—you can never tell!

A long letter from Charlie O'Brien, W2EQS (Westwood, N.J.) is dated December 11, and before that date he had heard no DX on the band except VP7NY (1998 kc) and CO7SW (1889 kc). The latter was S9 with him, but he was only tuning up and didn't call CQ; Charlie nearly went crazy calling him, and has since written to get him going. Stations whom he knows to be capable of working the band now include, HK1HV, HK1QQ, PY2BZD, CO2QR, HH2V, HC1AGI, HR3HH, YU1GM and EL4A (the latter with 1kW!) VP8GQ (G3LET) has also promised to be on the band at 0500 GMT.

Concluding note from W2EQS—he has now worked 30 countries on One-Sixty!

And so to W1BB's DX bulletins, the last two of which contain enough news to stock a whole issue, let alone this feature, so we will extract just those notes that concern G activities. He confirms that December 17 was "terrific," and at the opening of the test, 0500, the band came alive; breaking through right away were G6BQ, G3PU, G3CHN, G3ERN, G3OQT and GD3UB, followed later by G3MBN and G3OIT. They all stayed in until 0800 and many QSO's were made. Stations most frequently worked were W1BB, 1PPN, K1KSH, W1HKK, W0AIH/VE3, W9PNE, 2EQS, 2GGL and 8JIN.

The next test was on December 31, and the main excitement was the appearance of HC1AGI on 1807 kc, CQ'ing repeatedly but apparently hearing nothing; however, he worked W1BB at 0645, following up with W2IU and W9HBB. G3PU got across on the same night, and VP7NY and 3AD were also active.

Now sundry news concerning DX on 160 metres: OH3NY writes full of hope that special licences will be granted and that he will be back on the band again... EL4A and his xyl EL4YL will both be on with their "full gallon" before long... G3MBS, who was very active at ZC4AK last year, says that no one in ZC4-land is now interested in Top Band—pity... G2PL showed up again and raised VE1ZZ on December 21, 0700... KP4AXU is not allowed to transmit but is doing considerable listening... W1RAN plans some FP8 operation this winter and will include One-Sixty... W8JIN is trying to get 5A1TW (K2KUR) to come on the band. He is chasing a licence at present.

Late Flashes: On January 6, G3PGM (Reading) heard W8HGW working KH6IJ and identified the latter, just at the band edge. Then, on the 7th, he logged W1BB/1, W1PPN, VE2AYY, K8HBR and finally W2FYT calling HC1AGI. (W1BB was calling PZ1AT and was at times up to S7-8.)

G3KOR (Liverpool) has heard a fine bunch of W's and VE's, and worked VE1ZZ and UB5WF. He thinks the DX is far more consistent around 0200 GMT this season, and heard two W's on SSB, very strong, at that time. Unfortunately, at that early hour they tend to chat with one another and don't listen for Europe.

G3NVO (Middlesbrough) reports that January 7 was excellent for reception (he heard W1BB/1, K3KMO, W1PPN, VE1ZZ and a W2); but it seemed that conditions were not so good on the other side, due to QRN and the like; he worked VE1ZZ earlier in the year but is still waiting for his first W. On December 24, G3NVO raised UO5AA for his fourteenth country.

[over

TOP BAND COUNTIES LADDER

Station	Confirmed	Worked
<i>CW and Phone</i>		
G2NJ	98	98
G3JEQ	98	98
G6QN	98	98
GM3OM	98	98
G3IGW	97	97
G6VC	97	98
GM3COV	96	96
G3KOR	95	98
G3APA	92	93
GM3AVA	92	92
G2DF	91	91
G2CZU	90	90
G3LWQ	89	91
G3NFV	82	83
G3NNO	78	91
G3NVO	78	85
G3OHX	78	83
G3OSE	74	81
G3NTI	74	75
G3NNF	66	74
G3OIT	60	81
GW3CBY	54	65
G3MGI	54	62
G3PGN	53	63
G3OLN	52	78
G3ISX	48	54
G3IDG	46	49
G3PDM	43	68
G4JA	40	53
GM3PBA	36	49
G3PEK	6	35
<i>Phone only</i>		
GM3AVA	90	90
GM3OM	87	89
G3FS	85	85
GM2UU	80	81
G3NPB	79	81
G3NBT	73	75
G2CZU	69	69
G3NAA	64	65
G3NNF	56	60
G3NNO	46	70
G3NFV	36	48

(Failure to report for three months entails removal from this Table. New claims can be made at any time.)

G3PGN (Laindon) logged a few W's on January 7, and on December 31 he heard G3LIQ calling HC3AC. Apparently VE1ZZ came back to one of G3PGN's calls, but 'PGN didn't hear him and only learned about it afterwards—hard luck! (Might have been the first G3P . . . crossing.) He has some rude things to say about operating techniques on both sides, but nothing we say seems to have any effect, so this time we'll leave it unsaid.

G3FPQ says that HR3HH is now active on CW, and that VE3BQL/SU will also be on the band shortly.

G5JU was there again on January 7, working W1BB/1, W1PPN, W1TX, VE2ATU and VE2AYY, it being their first G contacts for W1TX and VE2ATU. Stations heard were W2FYT, W2UWD and VE1ZZ. There was a good deal of inconsiderate operating on the U.K. side, and two G's who ought to have known better were below 1820 kc, covering VE2ATU and others. Why *do* people do this sort of thing?

A note from G3NOT includes a very interesting QSP from 5N2JKO; though Top Band txm. is not allowed in Nigeria, he is QRX and, on January 7, the following U.K. stations were heard by 5N2JKO, 0530-0630 GMT, at an average of RST-569: G3PRN, G3PU, G5JU and G6BQ. He also logged five W's (including W1BB/1 at 599) and HC1AGI.

A quick check on the January 14 test showed that conditions to VE and W were pretty poor, but an amazing signal was coming over from HC1AGI — quite the best ever heard from South America on 160 metres.

Top Band — Normal Usage

In the excitement of the rare DX, one tends to forget that this band is still a hive of activity for those very many stations who couldn't be less interested in working W's and VE's—partly because they feel that their aerials are not good enough, and partly because they don't want to turn out in the early hours of Sunday mornings!

The select position at the top of the WABC Ladder (98 worked and confirmed) is now joined by

G6QN (London, S.W.19), who has achieved this with an aerial never exceeding 20 feet in height or 60 feet in length; in fact, he made his WABC with only 33 feet of wire. So, as he says, "What started as an attempt to prove that all G-land could be worked with a short back-yard aerial and a genuine 10 watts has now been accomplished." Fine work, too—and he wants to thank the many DX-peditors, especially G3APA (Sark), GM3COV (Sutherland), G3NNO (Westmorland) and G3LXP (seven Welsh counties). The chase took eighteen months of nightly operating; and some counties had to be worked six times (Dumfries seven!) in order to get a card. Reg concludes: "And if you re-start the table I'll do it again"!

G3PDM (Durham) has been hearing and calling some of the DX, but no luck as yet. He remarks that he hasn't yet heard the DL's this season and that HB9 is pretty elusive. However, Ayrshire and West Lothian helped his score along. He sends his entry for the G3O/G3P table (22 counties, 5 countries), but as we have explained elsewhere, the first appearance of that new ladder must be delayed until next month.

G3PEK (Stockport) has been more active on One-Sixty than any

other band, and has raised EI3AH, EI4AE, HB9T and eight OK's. He has also heard UB5WF, and tells us, on the side, that a local station (G3CNM) has worked 72 different OK's on the band.

G3ESP/M (Doncaster) drops a line to say that he is active at present on Top Band only, and feels that when he gets back on the HF bands again he will have to re-learn the prefixes. He also asks what "QTHR" means . . . the answer to that is "QTH OK in Call Book." It is a very old-established, though unofficial, Q signal . . . we were using "QRAR" many years before the war, and it was, we believe, originated by the ARRL as a time-saver. Much more use might be made of it on the air.

DX News from All Over

ZD8JP runs 20 watts to a "piece of wire on a bamboo pole"; he is on most Thursdays, after a sked with ZD7 (14022 and 14062 kc) . . . XZ2SY is active on 14 mc SSB after a long absence . . . The Caribbean SSB operation should have transferred from FY7YI to FM7WQ, or even further, by now (the latter was due to appear in mid-January).

Ruanda-Urundi may complicate the African issue still more: It was announced from Brussels late

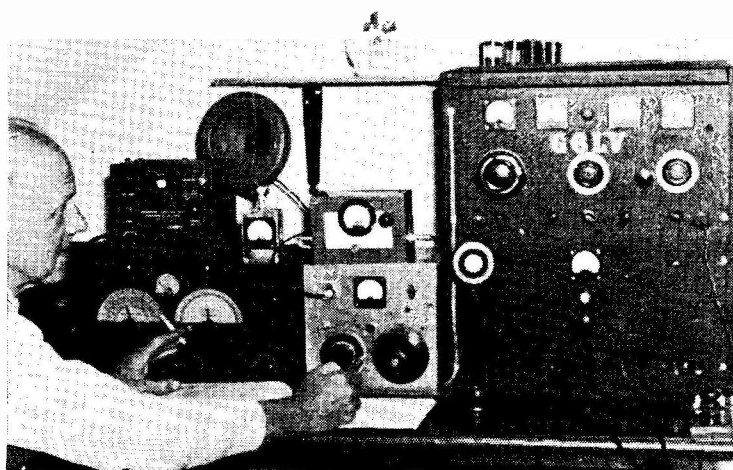

G6LV is operated by H. Wright, 2 Garland Place, Helston Road, Penryn, Falmouth, Cornwall, who started in 1926, having been a listener to "2FL of Warminster"; he used to transmit on the old Cardiff station wavelength on the medium-wave band for which amateurs were licensed in those days; of course, 2FL had to wait until Cardiff had shut down! The gear used now includes a Tiger TR-60, with Z-match, SWR meter and field strength indicator, the receiver being a pre-war RME-69 with DB-20 preselector, that famous combination.



Anniversary dinner of the Hong-Kong Amateur Radio Transmitting Society on 2 December 1961 was marked by the taking of this photograph of all present. Those identified are, front row, left to right: VS6EK, VS6ET, VS6EP (with the president's trophy) VS6EM, VS6DS, (guest), and VS6DK. Second row: (guest), xyl VS6ET, xyl VS6EG, xyl VS6EP, (guest), xyl VS6EN, (guest), and xyl VS6DS. Third row: XZ2AD, xyl VS6EK, xyl VS6EL, xyl CR9AI, (guest), (guest), (guest), and xyl CR9AI. Fourth row: (guest), VS6EL, CR9AI, CR9AH, VS6EN, VS6AE, (guest), VS6EQ, VS6BE, and VS1GC. At the back, left to right: VS6BH, (guest), Mr. R. V. Talbot-Jones, Wireless Engineer H-K G.P.O., VS6EG, XW8AS, and on the extreme right VS6DJ. The president of this lively and active society is VS6DS and the hon. secretary VS6EK.

in December that greater autonomy would be granted as from January 1, with Ruanda becoming a republic and Urundi a kingdom. Anyone heard any 9U's lately? Looks as though we might expect *two* new prefixes from there!

The Baja Nuevo (HKØ) trip planned by HK1QQ is now scheduled for April 27 if all goes well . . . VQ8BC will be going to Rodriguez Island in May, and his call will be changed to VQ8BCR; mostly 14 and 21 mc CW . . . FB8YY will be operating from Adelle Land by the time this is published, and FB8WW should by now have caused a stir from Crozet.

OY7ML (Faeroes) is being sent a tri-band beam from the States; he is very active again on CW, SSB and AM . . . Bryan Bisley has applied for permission to operate from Jordan (JY), but

apparently JY2NZK's operations therefrom made the authorities rather sticky and there is now some doubt about whether a licence will be forthcoming.

W4BPD's mammoth marathon appears to be "on." The main scoop seems to be the completion of arrangements for the necessary boat trip from VQ9 to VQ7, and Gus has applied for the call VQ7A. He has been assigned the call VK2SI for use from various territories under British administration—whether we shall hear this call with a variety of different suffixes remains to be seen.

FW8AS still hopes to open up from Wallis Island in April next . . . Heard Island (VKØ) should have been on SSB during January—call unknown . . .

Danny Weil was still reported as suffering from engine trouble in the *Yasme*, but his first port of call was to be the Marquesas,

whence he would sign FO8AN.

YVØAA took the air again from Aves Island during early January, activated by members of the Venezuela Radio Club with the assistance of the Venezuelan Navy . . . T19SB (SSB only) was due to show up from Cocos Is. around the second week in January, also . . . W8VDJ is in the Caribbean area for the winter and promises operation from Dominica (VP2DX) and other islands, on AM and SSB.

G3OGC (Romford) is going out to Bahrein, whence he hopes to be on the HF bands shortly with an MP4B call . . . Rumours are still rife of VU2NR activity from AC3 and AC5, possibly late January or early February . . . 5U7AC, who has been making Niger so easy to work on the HF bands, returns to France on leave at the end of April . . . VQ8APB (St. Brandon) made only 27 con-

tacts during his visit, running low power with battery supplies and drifting badly.

Things They Say

"Why do certain amateurs insist on breaking into a net with the cryptic announcement 'W8ABC on frequency, Bert'? If the gent in question is, in fact, on the frequency, surely this news is superfluous . . . however, the caller is usually at least 2 kc off zero beat and quite liable to drift plus or minus 5 kc in the following few minutes." (*QTC, Nairobi.*)

"If you consider it imperative for you to break into an established net immediately, for reasons best known to you only, and for reasons that are seldom all that important, just announce your call-sign *once* slowly and it will suffice to make your presence known. It will be quite obvious that you are almost on frequency without your rubbing in the fact." (*Ham Ques, Kalamazoo.*)

L F BANDS TABLE

(Countries Worked)

Station	7 mc	3.5 mc	1.8 mc
G3FXB	152	78	9
G3FPQ	136	92	20
G2DC	135	100	12
G3IGW	95	51	19
G2YS	94	73	20
G3HZL	81	44	8
G2BLA	73	39	9
G3JWZ	62	52	9
G4JA	57	41	9
GW3CBY	52	33	14
G3DRN	42	13	9
G2DHV	35	25	5
G2FQW	33	4	1
G3NYA	32	23	9
G3NYQ	31	28	11
G3PEK	30	16	8
G3NFV	27	25	16
G3NNO	24	23	10
G3PDM	23	10	8
G3OQK	23	5	7
G3IDG	22	16	9
G3NPB	21	8	9

This Table derives from Countries Worked. Order is based on band in first column, changed monthly.

"If you were asked by someone who is not an amateur, just what causes an amateur to forsake his friends, family and all his worldly goods (except his rig) to spend all his time on the air, what would the answer be? In one word—*Awards*. The Award is the culprit that provides the drive. The Award is the symbol of recognition, the positive proof that the transmitter is a real hot RF generator, that you have an SWR of 1:1 and a receiver which selects only the stations that will add to the award total." (*Collector and Emitter, Oklahoma City.*)

"House for sale: of special interest to hams. Telephone pole, ground stakes, coax lead-throughs and indoctrinated neighbours . . ." (*Advt. in Western Radio Amateur.*)

"During an interview, when the question of outside interests came up, a young man said 'my avocation is Amateur Radio.' The personnel manager laid down his pen, looked sternly at the young man, and said: 'Young man, directors have avocations; department heads have hobbies; what you are doing is simply—messaging about!'" (*Radial, RAIBC.*)

Miscellany

It might be interesting to hear from our regular readers (when we have established postal communication once more) concerning the amount of time they spend on the various bands. It's just one of those things that we never know unless someone volunteers the information. G3OLN (Cheltenham) may be typical of quite a number: 80 per cent Top Band, 8.4 per cent *Eighty*, 4 per cent *Forty*, 5.7 per cent *Twenty* and the rest nowhere. Other "statistics" in his letter: 960 QSO's in 1961; 450 QSL's sent out, and 155 received; 78 counties worked on Top Band, the first 62 of them in twenty-nine consecutive days. And he saluted 1962 by working, in the first two hours of the New Year, seven counties on Top Band, including Inverness and Renfrew.

G3OGO (Croydon) has changed his outlook a lot, and from being a 20-metre DX enthusiast he has now turned into a self-confessed "Rabid 160-metre phone fanatic

. . . still DX-happy, but shouting through Loran, ship-to-shore, singing Frenchies, static, pirates and loving every minute of it!" Top Band seems to be receiving an awful lot of notice this month, but undoubtedly more and more activity is transferring there from the other bands, so what can we do but report it? One day the QRM level there will be so fearsome that a migration in the reverse direction may well start up.

G3KJP reports that Chelmsford Amateur Radio Club put a station on the air during the Marconi Sixtieth Anniversary, and the call-sign used was GB2MT. (Only the Old Timers will see the significance of that one—"2MT, Writtle, near Chelmsford" was one of the most famous announcements of all time in the pre-BBC days.) However—GB2MT was on the air for nine days and worked 466 stations. G3KJP is handling the QSL's.

G3NWT (Sandiacre) writes from a horizontal position in bed, as a direct result of operations after the recent snow-fall! We hope he is around and on the bands again long before this is published. One comment from him is that a leak in the shack roof demonstrated that water can permeate by capillary action through 2.500 QSO's in a log. The XYL and some crafty work with the oven saved it, and the ink has only run in a few places where a rare DX station was annotated "Will QSL direct."

VK6AJ (Perth), who wrote recently about the scarcity of DX in that location, reports a turn for the better and says he has worked KW6DG, 4S7EC, KR6AF, JZØML, XZ2TH, VS6AE, HS1R, CR9AH, VS4RM, DU7SV and VK5XK/VK9—"all DX to you, but local to me"—as well as OH2OW, UW3ME, LZ1KSV and DJ2RE—"DX to me, but local to you." He recently scrapped his ground-plane and put up a dipole, and says "I haven't been so thrilled with Amateur Radio for years." He raised G2DC and G2CNN and cackled madly to himself like a man who has just discovered water in a desert! (Now we wonder what was wrong with that ground-plane . . .)

To continue—VK6AJ says he

enjoys his DX, but thinks the character who is busting a gasket to get his 200 or 300 confirmed has let the whole thing get the better of him and is heading for ulcers. "There is so much stress and strain in everyday life that a hobby should be relaxing, not a nerve-twitching rat-race." And how we agree, as regular readers will know.

Playing them Back

G3PDM remarks that the main diversion at his station has been the arrival of a tape deck, and the necessary amplifiers and so on are being built, "so that people with lousy signals can hear what a mess they make of the bands." This is an excellent idea—on paper—but we have found that, by the time a signal is recorded and played back, it is pretty difficult for the recipient to tell how much of the distortion is on his own signal, how much due to the station doing the playback, and how much due to conditions in both directions. Unfortunately, a tape-recording is remarkable only when the whole operation succeeds in producing really excellent quality back at the original station. We have heard some playbacks of pretty good-quality transmissions which have sounded vile—usually, we must admit, through being recorded *via* loudspeaker and microphone and then played back through yet another loudspeaker and microphone, which doesn't give the best-quality signal a chance.

Recordings of local signals, made over a period, and then played back at a Club meeting, can produce quite a salutary effect—but over the air we find they are always treated with a certain amount of polite scepticism.

Eighty Metres

G3FPQ (Elstead) has been continuing his DX work on Eighty SSB, and during the past month has worked CN8IK, HR3HH, HZ1AB, KG1FD and 1GC, KP4AQQ, 4AWH, LX1DE, PJ2AA, PZ1AX, VE3BQL/SU, TG9AD, VK3AHO, 3BM, 3HG, 3JA and 5QR, VP5BL, 5CH, VP9DC, VE's, all W districts, YV5AHG, 5ANS, ZC4PC, ZLIACG, 1AIX, 2AAG, 2AJI,



When on a recent business trip through Canada and the U.S., G6CJ (seated) visited W1BB for a discussion about DX on Top Band. Both are very well known in this field, G6CJ having worked three ZL's on 160m. by meticulous calculation to take advantage of the "shadow-edge" transmission path. W1BB has been putting an S7-8 signal into the U.K. during this season's Top Band tests. (A W1BB print)

3UC, and 3V8CA. (Yes, we *did* say Eighty!)

David has found conditions on the band far better than last year, with the VK's sometimes getting S9 reports from Europeans. Openings to VE have occurred as early as 1830 GMT, and to ZL as late as 0900. VK's have been readable for 1½ hours on occasions, and co-operation during skeds with VK3AHO has been first-class.

G3FPQ writes: "I still feel 80 metres is the best band of the lot for general friendliness and observance of the 'amateur spirit.' My one complaint relates to the few stations with SSB transmitters that *can* produce good clean signals, but deliberately push the drive up so that their splatter covers up weak signals on adjacent channels . . . most SSB stations accept reports that their signals are not clean in the spirit in which they are given, and immediately try to rectify matters, usually with the help of the station who informed them of the trouble. The odd few who don't, spoil the DX game for the rest. To sacrifice one's reputation on the air for the

sake of half an S point from DX just doesn't make sense to me."

Graham Knight, an SWL in Aberdeen, sends his log of Eighty SSB DX (December 25-January 8) and it includes CN8IK, OY7ML, VE3BQL/SU, KG1's, UC2AA, VP5BL and 5CH, YV5ANS, five VK's, six ZL's, eleven VE/VO's and a host of W's including 6's and 7's. He, too, remarks on the open hours, and has logged VK's as early as 1700, and VE2AUU as late as 1100—all on a 100-ft. wire and a modified Eddystone S.640 receiver. It is interesting to note that SWL Knight has logged all this lot on SSB, but says he has heard *nothing* from over 1000 miles on AM.

The HF Bands

Because of the paucity of home news, we are lumping these together this month—all bands, all modes—and instead of running lists of Calls Worked, we shall have to mention them as they arise.

GI3NPP (Dungannon) was the first European to work G3JFF when he came on from YJ1MA,

and they exchanged 579 reports. Others worked on 14 mc CW were YVØAA, YK1AK, FM7WP, ZD8JP, PJ2ME, LU3ZM, KC6BD, VP4BY, JT1KAA, HM4AQ, 9M2UF and UAØKYA. VP4BY proved to be VE6BY taking a holiday in Tobago; YK1AK mostly works W's on the long path around 1400; YVØAA, the expedition, came up on 14 mc CW and SSB, also 21 mc AM. QSL's arrived at G13NPP from VQ8BM, PJ2ME, HM4AQ, ZK2AB, ZD7SE and XT2A.

GM3JDR (Sutherland) reports conditions very poor, with Twenty dead by the time he could get at it—hence a very lean list compared with his usual effort. So his best worked during December (all on 14 mc SSB) were EP2AT, KP4, OD5CW, PJ2AA, PZ1BF, TF, UA9, UW3, VK3HL, VKØVK, ZB1A, ZS's, 5A's, 5H3HH and 5N2EBL. QSL's in from ZS7S, KV4CF and H18GA.

MP4BBW (Awali) was disappointed to find his WPX score only 494 at the end of the year—he had hoped to make the 500. He thinks Twenty has held up very well, and is now starting to improve. The smoothed sunspot number is now lower than at any time since he first came on the band in 1955, but *still* he works the DX with no trouble. Early mornings and late afternoons are the best times out there; a selection from his long list (all Twenty SSB) provides the following: PJ2AA, AP2AD, VP5BL, XW8AS, 9M2CR (ex-AP2CR), VR6AC, XZ2NS, 5H3GC, 3GX, 3HH, K6OTJ/KJ6, VPØRT, FK8AC, CR9AH, W6QMN/KB6, KM6BI, EL2V, KX6BQ, 5N2EBL, K6CQV/KS6, KW6DG, XE1AB, HS1X. Ian has now heard Europeans on *Eighty* SSB, as early as 2000 GMT, but he hasn't got his own aerials up yet.

G3PEK sends another five-band report, although he has been running very QRP through the failure of a power supply. With 8 watts on *Fifteen*, he raised CT2AI, a new country, as well as W's and VE's. On *Twenty* he also found some new ones, including an FA8 with six watts; on the same power he found no difficulty in working W's and VE's, but it does

rather shake some of the W's with a kilowatt and a 3-el. beam to find they are working a station with 6 watts and a "piece of wire." *Forty* yielded only Europeans, although DX heard included VP8GG and CP5EZ; and *Eighty* was used only for short-haul stuff, although a 579 from an HA was accepted with joy!

Our own quick summary of the HF bands, based on spot checks at various times of day: 21 mc is sometimes surprisingly good in the mornings (1100-1300) but seldom has more than W's to offer in the afternoons, and often not even that. The 14 mc band is full of European short-skippers until mid-day, with the W's breaking through around 1130; but during the afternoons most of the short skip vanishes and leaves the band very much as 21 mc used to be a month or so ago—plenty of varied DX with the accent on W6 and W7 around 1600-1700. The fade-out time is now much later and all kinds of DX shows up in the early evening, rather unpredictably. (G6QB worked ZL4GA at 1630 one day—quite the wrong time for ZL contacts, but good solid signals both ways.)

G3NOT (Catterick Camp) has found the HF bands "up and down" but nevertheless worked a lot of AM phone DX, including OA8T, HK1MT, VU2BK, YV5RYD, and ZD6RM, also

VK2, 3, 5, 6, ZE's, ZL's and various African stations—all on 15 metres. His 10-metre list mentions CT1LC, CR7ID, ZD6PR, ZE1JN, ZE3JU, ZE7JO, ZS6AOW, ZS6LX, ZS6BDU and W1CHG. G3NOT also passes it on that ZE1AY is an ex-G looking for stations in Cornwall on 15 metres.

More Miscellany

Among the last-minute letters was one from G3LKJ (Torquay), who is unfortunately languishing in a London hospital bed, where he has been for two months; we hope he is on the mend and well on the way back to being on the air again. He is looking forward to the 14/21 mc DX Marathon, which, like the new Top-Band Ladder, has to be held up until next month for lack of entries, due to the postal delays.

G3NWT, in a later letter, reports that he is up and about again. He says that Angus, 5N2AMS, has had three trips to TY2AA so far, with more to come. He has nearly made DXCC from there and has WAS several times (with 643 W's worked in a row). G3NWT worked him just as he was turning over the pages of our December issue with one hand and tuning Fifteen with the other... 5N2AMS saw Geoff's remark about TY2AA and phonetics, and heard his CQ simultaneously. (That's one way to get replies to CQ's!)

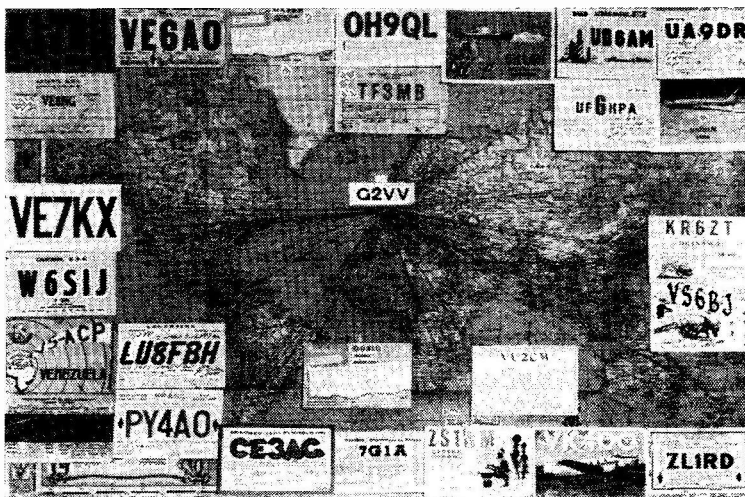

What can be done with an indoor aerial on the HF bands. G2VV, 53 Thames Street, Sunbury-on-Thames, Middlesex, has made QSO's of this sort using equipment that has been illustrated and described from time to time in "Short Wave Magazine."

DX worked on *Fifteen* by G3NWT included FB8XX, ZE2JA, ZD6RM, 5H3PBD and 5N2AMS. A letter to him from 5H3PBD gives the following DX worked, all on *Fifteen* AM: TG9US, YN6HH, 6AH, ZS81, 6W8CU, VP5CW, EU2BK, ET2US, DU6RG, VQ8BA, XW8AL, VK9GR, VS4RS, 5U7AC, FB8ZZ, ZP5CF, XE2AX, VP9AK. Activity out there includes 5H3GC and 3IP on *Fifteen* AM, with 5H3HD, 3HL and 3HZ all on CW. 5H3IP is also reported on *Forty*—presumably CW.

Final thought: "The appeal of phone is that it's a form of public oratory. The more socially retiring a person, the more his inward longing to have a bash at it. The layman can only dream of answering a police telephone in a crowded thoroughfare, or exchanging rhetoric with an erring bus driver—but Amateur Radio opens much wider horizons." (May be something in that, too.)

Our Heading Photograph (p.636)

ZB1RM is operated by R. V. Meachen from 149/3 St. Dominic's Street, Valetta, Malta, where he is a master at the Government Nautical and Wireless School. ZB1RM is ex-R.N. and was also in the Merchant Navy as a radio officer. The station is on the roof of a block of flats "with a lovely view overlooking Grand Harbour"—and anyone who has been out there knows what a wonderful sight that can be. All the gear is mounted in a console, the Tx being a Geloso VFO driving an 829B as PA to 75w.; the receiver a CR-150 with a Geloso converter, thus making it a triple-conversion Rx layout; and the aeriels are a 15m. Cubical Quad, with parallel dipoles for 15 and 20 metres, and a G/P for 10m. Activity is more

or less daily, mainly on 15m. phone, though CW and phone are also worked on the other bands.

Last-Minute DX Notes

FY7AA is a permanent station at a technical school, and is scheduled to be on 3.5 mc this season . . . SSB operation from UH8 and UG6 is promised by UA1CC—about three weeks from each place . . . VKØVK was due to be leaving Wilkes Land in mid-January; on the way back to Macquarie, where he is due at the end of February, he hopes to operate from Chick Island, Lewis Island and Oates Land. These places have never before seen any amateur activity; and this time they will only be one-day stops, maybe for merely a few hours.

Latest advices suggest that these should have been on during January—did you find them?: FB8WW, *Crozet*, 14 mc CW only; YVØAA, *Aves Island*, three bands AM, SSB and CW (we can confirm this one); TR8, *Gabon*, by 5N2AMS/TY2AA; TI9SB, *Cocos*, SSB only; VE4BY, *Tobago*; FO8AN, *Marquesas*, by Danny Weil; AC5, *Bhutan*, by VU2BK and 2PP (21 mc AM, 14 and 7 mc CW and AM).

And just one left over which you still have time to rout out: VP5BP, *Cayman Is.*, operated by VE3CJ, probably AM and SSB only. He states that this is a holiday, not a DX-pedition, and will operate accordingly.

Finally, a note about the Top Band operation from HC1AGI: The station is 11,000 feet up in the Andes and the aerial 300 feet long and 80 feet high. But the location is at the end of a very rough one-hour drive for W3EIS, who will be doing the operating. He promises to be on during both week-ends of the ARRL CW

Contest, February 16-18 and March 16-18.

World-wide Top Band Contest

Don't forget this event, running from 0200 on February 24 until 1400 on February 25. Whether you take part or not, it will be an opportunity for DX-hunting. Full details were given in last month's *Commentary*, p.581. We repeat that it is possible for a G station to win this world-wide event this year, in view of the scoring system and the large number of G's that can be worked during the 36-hour period, together with the multiplier.

The only deviation from normal contest rules is that, instead of sending the RST and serial number as a six-figure group, you send the QSO number first . . . Nr 1 G7XX 579 Eng., and so on. US and Canadian stations send their State or Province. Two points for your own country, five for other countries, but ten for Trans-Atlantic QSO's. Good luck!

And that brings us to the end of another one, with more apologies for the "circumstances beyond our control" which have made it a little scrappy. The two new tables—the 14/21 mc DX Marathon and the G3O/P Top Band Ladder—will start *next* month, as we simply have not received enough entries to make them worth while. If you have written this month but your notes don't appear, you will know whom to blame. Next month's deadline is an early one—**first post on Friday, February 9**—and if the postal muddle is still "on," please make it at least two days earlier if you can. For the April issue, it will be *March 16*. Address it all to "DX Commentary," *Short Wave Magazine*, 55 Victoria Street, London, S.W.1. And, for now, 73. Good Hunting and — BCNU.

HOLD UP CERTIFICATE CLAIMS

Because of the postal disorganisation prevailing at the time of writing, the processing of claims for our DX Awards and Certificates is being held up. Readers

who contemplate putting in claims involving large packets of cards are advised to hold them until mail distribution becomes normal again.

Short Wave Magazine is Independent and Unsubsidised — It has significant circulation in more than 70 countries outside the U.K.

Aerial Hints, Tips and Ideas

Based on the experience of

THE OLD TIMER

Part II

This time our contributor deals with the problems of feeding single-ended aerial systems—long wires, end-fed half-waves or quarter-waves—and stresses the necessity of building the right type of ATU, and of taking trouble over details such as the size and the positioning of the link winding. Similar problems connected with Zepps, doublets and all types using open-wire feeder will be discussed later.—Editor.

THERE are times when one thinks that the major problem in Amateur Radio must be the transference of power from inside the shack to the world outside. It is hardly possible to listen on the bands for half an hour without hearing some frustrated character say "I've got up a new aerial but it won't load," or "This bit of wire is all right for Eighty but I can't make it draw on Top Band" . . . and so on.

This always surprises me, for one can make any "bit of wire" load up on any frequency, given sufficient tenacity of purpose! Whether it will radiate satisfactorily is another matter, but one can always transfer power to it (or "make it draw," the beloved phrase hanging over from pre-war days). This difficulty can only be explained when one also notices the numbers of people who say "I can't be bothered with an ATU—I am feeding the aerial straight off the π -network of my PA."

Well, unless you are all set to use a dipole or a parasitic beam for each band, you will sooner or later have to face the fact that an ATU is a necessity. Far from being a nuisance, it is one of the most important items of gear in the shack, and can bring enormous improvement in efficiency to both the transmitter and the receiver. Furthermore, it will repay the spending of a lot more time and trouble than the average amateur usually spares for it.

Single-Ended

Forget all about dipoles and beams for the present, and imagine that you have a piece of wire with a total length of around 132-136 feet hanging up outside. This is roughly a half-wave on Eighty, full wave on Forty, and so on. The station end of it will look like a fairly high impedance on all bands except 160 metres, where it is a rough sort of quarter-wave and will have to be fed at low impedance, Marconi-fashion.

Now how on earth would you get away with *that*

without an ATU? In the "good old days" (questionable term where this is concerned) we would have clipped the thing straight on the tank coil, finding the turn on which it loaded up best. No TV then and not so many stations on the band to complain about broad signals! Nowadays we can still get away with the nearest equivalent to this, by link-coupling the tank circuit to another tuned circuit, and finding the best part of the latter on which to clip the end of the aerial.

It may look like, say, 1,000 ohms or so on Eighty and Forty; but by the time we are using it as a long wire on Twenty and Fifteen the chances are that the impedance will be much lower (more of that later). But whatever it looks like, a match *can* be made. For Eighty, if the wire is cut to anything like the right length, a simple parallel-tuned circuit with the aerial tapped right at the live end (or just a few turns down) will suffice. But for any band on which it looks like a low impedance (Top Band being the extreme case in this example) a series-tuned circuit will be necessary.

Note, now, where the link coupling into the ATU will need to be. Fig. 1 shows (a) the parallel-tuned circuit, earthed at the bottom end, with the link right down at that end; (b) the series-tuned circuit with the condenser at the top of the coil and the link still in the same place; and (c) the series-tuned circuit with the condenser at the *bottom* end, which means that the link must be re-positioned at the top of the coil. (Consider the impedances in this circuit and you will find that the lowest impedance is at the point where the quarter-wave aerial joins the top of the coil. You will probably be able to strike a neon tube at the lower end of the coil, especially if the number of turns is such that only a small amount of capacity in series with earth is needed to tune it.)

Placing the Link

This business of positioning the link is one which is ignored by a surprising number of people and treated as unimportant by many more. In reality it means a great deal. I have been experimenting recently with the invaluable SWR meter in series with the coax feed between transmitter and ATU. On some bands and in some conditions it has been

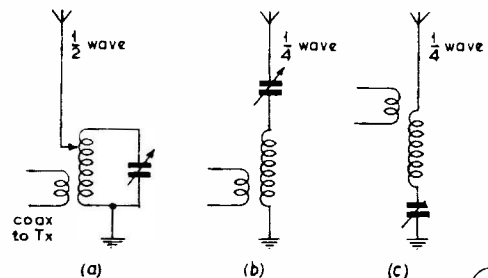

Fig. 1. A $\frac{1}{2}$ -wave aerial (a) requires parallel feed, which would be useless for the $\frac{1}{4}$ -wave type. The arrangement at (b) is widely used, but when changed to (c), so as to earth one side of the condenser, the link winding must be re-positioned—see text.

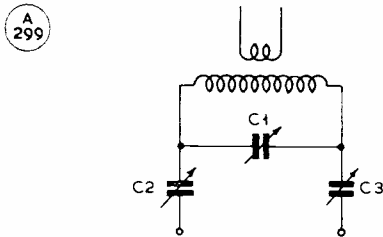

Fig. 2. Basic arrangement for a universal ATU which allows either parallel or series tuning. This can be ideal for symmetrically-fed systems with open-wire feeders, but is of little use for single-ended aeri-als.

found impossible to achieve a better ratio than 2:1 until the link is moved to the optimum position on the coil. Thereafter a figure of 1:1:1, or even better, is obtained, and I am never satisfied with anything worse than this figure. (Furthermore, a check on the actual current flowing into the end of the aerial will show that correct positioning of the link can give a lower SWR, a higher amount of power into the aerial and a lower input to the final stage . . . showing just how haywire the whole thing must have been before.)

It is obvious that our ATU cannot remain just a parallel-tuned circuit; we must make provision for either parallel or series tuning. This can be done by the rather cumbersome arrangement shown in Fig. 2, where C1 is used for feeding high-impedance arrangements, and C2/C3 where low impedance feed is required. But when dealing with single-ended aerial systems, which we are considering at the moment, we should still have to provide taps on each coil, so as to find the optimum connection for the aerial itself.

Flexible ATU

This brings us to the invaluable arrangement shown in Fig. 3, which has been described, praised, re-described and redrawn so many times that one can hardly believe that it still has to be explained to so many. In this case the two condensers C1 and C2 are in series across the coil. The net capacity necessary to tune the coil to resonance can occur at an infinite number of different settings of C1 and C2; resonance can be maintained while swinging both condensers round so that the net capacity of the two in series remains the same, but the impedance will be changing all the time.

If one connects the junction of the two condensers to earth, the effect of swinging them in this way is to slide an earth-tap up and down the coil. Leave the aerial at the end, always, but "tap" the earth on at the right place. That is how this simple but effective unit works. But since the coupling link should always be at or near the "earthy" part of the coil, we shall have to find the right place for it, on each band. If the condensers are so placed that the coil looks earthy in the centre, that is where the link must be. If C1 is at minimum and C2 effectively tunes the circuit, then we are using series tuning, and

the link will probably need to be along towards the aerial end of the coil. But if C2 is shorted out and C1 does the tuning, we are obviously using parallel tuning, the earth is connected directly to the right-hand end of the coil, as drawn, and it is at that end that the link must be used. Intermediate positions of the two condenser settings will necessitate intermediate positions of the link, also.

Arrange C2 with the outer edge of one moving plate bent over, so that it automatically shorts out when placed at the maximum capacity. Place it in this position and you can do your parallel tuning with C1, forgetting C2 altogether; reverse the proceedings, by setting C1 to minimum (choose a condenser with a really low minimum capacity, if you can), and carry out all tuning on C2, and you have series tuning. Somewhere in between, with both condensers in use, you will find that you can get a match into any impedance offered by the end-fed "piece of wire."

Now you will see why I do not approve of band-switched ATU's for this sort of job. You can't get the link in the right position for all conditions . . . but if you use a separate coil for each band, you can, by experiment, place the link correctly once and for all on each coil.

Size of Link

The number of turns in the link is another matter which is dealt with much too light-heartedly by so many people. If you have no SWR indicator you will probably never know the degree of mis-match between your PA and your ATU—but you can at least tell whether you are over-coupled or under-

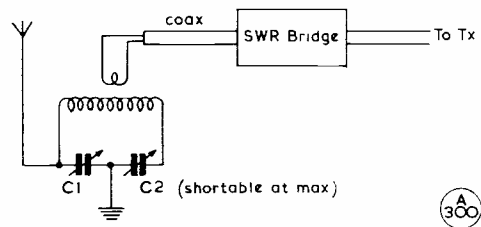

Fig. 3. The well-known arrangement to make possible either parallel or series tuning, together with all gradations between, producing a match into almost any impedance. In this, the position and size of the link winding are critical factors—see text.

coupled. An SWR, however, will show you the full story, and if you really strive to achieve the lowest possible figure (setting 1:1 as your goal, naturally!), you will be surprised at the amount of surgery that takes place on those link windings.

On my own rig (pi-output from the PA and separate coils for the ATU on each band) the correct size of link appears to be one turn for 28, 21, 14 and 7 mc bands (coupling into coils of 5, 5, 7 and 12 turns respectively); only two turns for 3.5 mc, and four for Top Band. Long wires of various lengths are end-fed directly from the ATU; but on other occasions when 600-ohm and 300-ohm feeders have

been coupled into the same ATU, the link numbers have remained correct. I had four turns of link on my 3.5 mc coil once, and the mis-match was terrific. Thinking they were not enough, I increased the number and saw at once that things were worse . . . so down it came to two turns, although it still works very nicely with only one.

On how many bands (if any) can you achieve *this* effect? Tune the PA to resonance without worrying about the aerial tuning. Make sure you are right down "at the bottom of the dip." Then swing your ATU condenser or condensers through the point of resonance, observing that the PA current rises up to the full normal loaded value *and* falls off again on the other side. If you can do that, your loading is just about right. Naturally, if you are hopelessly over-coupled, you will find that the PA current rises just when you think it should be falling, but that is because you have pulled it off resonance. Re-tune the PA and you will find the dip again, confirming that this is correct. You are over-coupled! Most probably your link has too many turns—and possibly it is at the wrong part of

the coil as well.

In the other direction, if you are under-coupled, the effect will simply be that you tune the PA to full "dip," swing your ATU condensers, and find that you can make it rise at a certain point, but not to its optimum value (which, of course, you should be familiar with). Figures at my own station for the PA are 750 volts and 200 mA; with the aerial off resonance the current is something below 40-50 mA, rising to exactly 200 mA and falling off again as the ATU is adjusted. (But when tuning up I usually use half voltage and half current anyway, thanks to an easily adjustable power pack.)

If reading the foregoing has given you an idea or two, or made you wonder whether your PA is really in communication with your aerial system, then you have plenty to play with. But it's a fascinating kind of play, and one that is always rewarded by the certainty that things have been improved. No time spent on ATU's and all that goes with them is ever wasted (unless the thing is perfect before you start, which is most unlikely). Good luck with it!

THE MAY R.A.E.

Those taking the next Radio Amateurs' Examination, in May, are reminded that their entries should be in before the end of *this* month. Applications to sit can be made through the instructor of a class organised under the Local Education Authority, *or* the Technical College or Evening Institute at which instruction is being taken, *or* through the local office of the Education Authority, *or* by reference to the City & Guilds of London Institute, 76 Portland Place, London, W.1. In all applications "Subject No. 55, Radio Amateurs' Examination" must be quoted. And for those who have not seen it, or may feel themselves a little rusty, we can recommend the *Radio Amateurs' Examination Manual* as a source of inspiration and helpful advice. We can supply it at 5s. 6d. post free; orders, with remittance, to our Publications Dept.

MARCONI STORY—INTERESTING SIDELIGHT

We have often wondered what became of Marconi's original gear as used at the Poldhu Station in December 1901 — see p.593, *SHORT WAVE MAGAZINE*, January issue. It now transpires that apparently most of it was bought at a public auction by Douglas Johnson in 1922, the year before he was granted his transmitting licence as G6DW. He and a school friend found themselves in possession of a large and varied quantity of spark transmitting gear, including an 18-in. spark coil, described as from "Poldhu Wireless Station." Many weeks were spent in making good the deficiencies of this equipment and

in getting it working; some transmissions were then made, quite illegally, on what G6DW says was "heaven knows what wavelength"; according to the wireless press of the time, their signals were heard from the Orkneys to the Mediterranean, and several records were created for ships' crystal receivers! There were also some encounters with other amateurs and the G.P.O., but all was well in the end. We need hardly add that Gp./Capt. D. H. Johnson, G6DW, is nowadays a law-abiding citizen on good terms with the G.P.O., and from Capel in Surrey can be heard on 80m. sideband with a very pure transmission — though he does say that the old spark Tx had a grand note!

AMATEUR LICENCE FIGURES

We are informed by the Post Office that as at December 31, 1961, the U.K. amateur licences in issue totalled 9,460—a nett increase of 461 for the year. Of the current total, 1,045 are endorsed for mobile operation (/M), and 99 for amateur TV transmission (/T). Though the overall total increases steadily, the growth is slower than one might expect because there is a considerable wastage, due to the number of people who drop out for one reason or another over any given period. Furthermore, by no means all the aspirants who pass the R.A.E. get as far as taking the Morse test; probably at least one third of those who pass never even attempt it. The interesting statistic in these latest G.P.O. figures is the marked percentage increase there has been in mobile licences during the last two years or so.

The second-hand value of all commercial Amateur Radio equipment is established through the Small Advertisement section of *Short Wave Magazine*

RTTY Topics

IMPROVING PRINTER OPERATION THROUGH INTERFERENCE— USING AN AUDIO FILTER— NOTES AND NEWS

W. M. BRENNAN (G3CQE)

THE story of RTTY development in amateur circles appears to be unfolding in much the same way as did the development of SSB a few years ago. Indeed, perhaps it is significant that several members of the present-day RTTY fraternity were among the early adherents of SSB. Roughly speaking, RTTY would seem, at its present stage, to be just about where SSB was five or six years ago. In many ways, the two modes seem to go together, and it is reasonable to predict that in the not too-distant future a large number of amateur stations in this country will be equipped for both modes of operation, providing reasonably-priced machines remain available. In amateur service, a T/P is not required to stand up to several hours of continuous operation seven days per

week, as on many commercial circuits. Consequently, there is the possibility that a comparatively inexpensive machine could be produced for amateur use. Indications are that at least one manufacturer is looking into the matter, and there are hopes for a small, compact machine that could be accommodated on the operating desk along with the SSB rig.

In the meantime, RTTY is gaining new followers in spite of the shortage of machines. ZB1FA has managed to get hold of a typing re-perforator and auto transmitter, and is active on 15 metres sorting out the inevitable teething troubles. A machine is on its way to XZ2AD; another is being shipped to VU2NR, who suggests that it should be used on a loan basis to various countries in Asia to spread interest in RTTY there and, at the same time, put these countries on the air for a while. This machine has been donated by W0NFA, who recently won the RTTY Sweepstakes contest. KR6MF and KR6GF on Okinawa have been joined by KR6HY and KR6DZ to make up a nice quartet for the island's RTTY activities. OY7ML (*see* p.27, March '61 SHORT WAVE MAGAZINE) is on the lookout for a machine so that he can add RTTY to his SSB and CW activities.

Activity

Conditions on the HF bands have been reasonably good recently, producing openings to VK and ZL on many occasions and, of course, to North and South America, too. K3GIF has been busy on 15, 20, 40 and 80 metres, keeping schedules with ZS1FD.

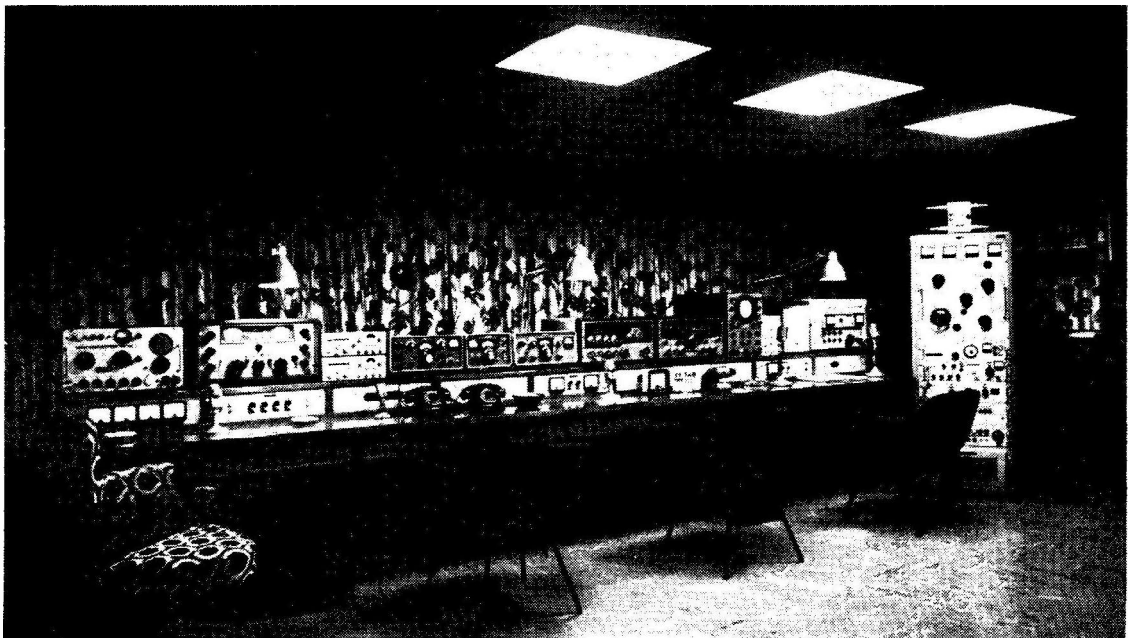

Station of IIRIF, owned and operated by Bruno Riffeser, Via G. Fara 41, Milan, where there is one of practically everything available in the way of commercial gear for the amateur bands (and some of it in duplicate). There is a lot more apparatus, along the sides of the room, not visible here. There are three operating positions, with a complete Tx/Rx set-up at each and, of course, a most elaborate aerial system which includes several beams. IIRIF has become prominent as an RTTY operator, for which the teleprinter is an Olivetti, one of the standard Italian makes. The apparatus shown in the photograph includes items of British, American, German and Italian manufacture, and some of it was described on p.535 of our December 1961 issue.

ZB1FA, G3BXI, G3GNR, G3FHL and G3CQE. This has meant some loss of sleep for him, but it has proved that contacts between the U.K. and the U.S.A. are possible on all four bands at this time of the year; 80 metres has proved rather better than 40m. in this respect, quite good copy being exchanged during 0700 to 0800 GMT in spite of the sundry demons of 80m.; 0800 GMT is 0300 local time for K3GIF, and so not the most convenient time for skeds! Nevertheless, he is willing to co-operate with any European stations that would like to try their luck on Sunday mornings on this band.

Improving the Copy

A question often raised by newcomers to RTTY is: "How can I improve on the receiving side?" Usually, they have in mind the building of bigger and better TU's and, of course, the terminal unit plays an important part in RTTY reception. However, providing it does give good printing on, say, an S7 signal that is in the clear, it is probably doing a reasonable job as a TU, and it is, perhaps, more profitable to make a critical appraisal of the rest of the receiving chain when seeking to make improvements. The T/P itself, for example; normally, this machine will accept some 35% signal distortion and still produce error-less copy. Obviously, the greater the distortion margin the machine possesses, the better will be the copy from it during poor reception conditions. If, however, the machine is not correctly adjusted, then the distortion margin is less and it produces poor results. An otherwise correctly-adjusted printer may be operating just within the distortion limits, merely because the motor speed is not correct. Time spent in adjusting the T/P is certainly well worth while.

RTTY and QRM

Probably the most usual cause of poor printing is QRM. Apart from the one case where interference lies within the mark or space channel, there is little that can be done in the TU itself to beat the QRM. Most TU's consist of a limiter stage, a discriminator and one or more keyer stages. The only built-in selectivity is in the discriminator. Since it is the function of this stage to discriminate between the mark and the space frequencies, it must employ some frequency-conscious elements. These can, of course, be two high-Q tuned circuits, providing that the passband of each of these circuits is sufficient to allow the 5th harmonic of the 25 c/s keying freq. (for 50 bauds) to pass through with little or no attenuation, to preserve the keying waveform. However, selectivity introduced at this point of the circuit is of little

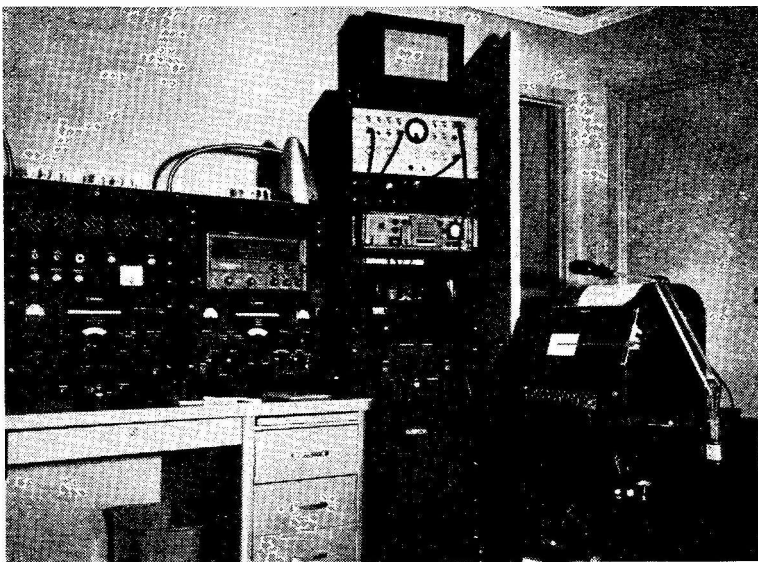

W5ANW, W. H. Carter, 3103 Kettering Drive, Houston, Texas, has a 75A4 receiver and a Collins KWS-1 transmitter. His printer is the Teletype Model 15, with a Type 14 reperforator.

real value, since it is preceded by a limiter stage; and so, in common with any FM system, any interfering signal of greater amplitude than the RTTY signal will capture the limiter stage and tend to suppress the wanted signal. Once this occurs, only an ideal discriminator could be of any use. Selectivity must therefore be introduced *before* the limiter stage—that is, before the TU itself.

It is not unusual on the amateur bands to find, say, an S5 RTTY signal a few kc away from an S9+10 dB phone signal. These two signals have a difference of 34 dB. If, therefore, the receiver IF/AF response is incapable of reducing the phone signal level by more than 34 dB when the receiver is tuned to the RTTY channel, severe interference will take place.

The moral is obvious: As with any other form of radio communication, the receiver bandwidth should be only that which is necessary for the full acceptance of the signal mode being used. The required bandwidth for an RTTY signal using 850 c/s shift at a maximum keying speed of 50 bauds is 1.1 kc—but in order to allow for tuning errors, etc., a reasonable compromise is 1.4 kc. Much has been written on the subject of receiver selectivity, and anyone who has doubts about the adequacy of his own receiver should have little difficulty in finding articles on how to improve it in the amateur handbooks. Since the advent of SSB, many receivers have been produced with excellent IF selectivity, having the required SSB passband of 2.5 to 3 kc, with a good shape factor. Although such a receiver has more than twice the required bandwidth for RTTY, it is easy enough to reduce the bandwidth in the *audio* system by the insertion of a bandpass audio filter between the

receiver and the TU. With a less selective receiver, such a filter will improve reception even more. The bandwidth of the system then becomes that of the bandpass filter, and the performance of the receiving set-up is greatly improved.

The audio type of TU requires two tones, one denoting "mark" and the other "space." These two tones are produced, as in CW reception, by beating the incoming signal (two signals for RTTY) against the BFO. The actual frequency of these tones is left to the choice of the TU designer, but they will be at 850 c/s frequency difference. If the freq. chosen is too low, however, trouble can result, due to BFO image interference; for example, if the lower of the two tones is taken as 500 c/s, then the BFO would be set 500 c/s away from the lower IF produced when the space freq. was being received. Thus, a signal only 1 kc away would also produce 500 c/s. This BFO image is not likely to be attenuated sufficiently by the IF response, and so a higher order of audio frequency is normally used for the two tones. (Remember, it does not much matter what it is, so long as the difference frequency is 850 c/s.) The problem is similar to that of superhet image interference. A bandpass filter following the receiver cannot remove this image, since the image produces the frequencies the filter is required to pass.

For TU operation, the two frequencies normally used are 2125 and 2975 c/s; this gives the BFO image at 4.25 kc separation from the required signal, and this spacing enables the image to be attenuated by 30 to 40 dB by the IF response of a moderately good receiver. The bandpass filter is therefore required to pass 2125 and 2975 c/s, plus the 125 c/s representing the 5th harmonic of the 25 c/s keying frequency—a total bandwidth of 2,000 to 3,100 c/s.

A bandpass filter incorporated in a commercial TU, the A.T.M. Company's "Adaptor Receiver Freq./Shift Type AP6682," is available on the surplus market from time to time, and is at present used by several amateurs in this country. The response of the filter is excellent, and it can give some 50 dB of attenuation to a signal less than 500 cycles from the channel. Another filter made by the same firm also comes up occasionally on the surplus market; this is labelled "Filter Unit FS Morse AP67981." It contains little other than the filter, a switch and two phone jacks, and sells for about ten shillings. Various amateur-made filters have been described in the past in *RTTY Magazine* and in *CQ*; the *RTTY Handbook* by W2NSD and W2JTP contains details of a simple but effective filter, designed by W2JAV, incorporating three of the 88 mH telephone-line

loading coils which are often used for discriminator filters in amateur TU's.

Noise of the random variety is directly proportional to bandwidth. Reducing the bandwidth by means of a filter of this type therefore increases the signal-to-noise ratio of the receiving chain and so the bandpass filter is a double blessing!

RTTY Contest Results

Just as this issue went to press the results of the World-Wide RTTY Sweepstakes Contest, October 21-23, were received—see p.408, October issue. The outright winner was W0NFA, with 33,738 points. The European leader was IIRIF, who made 25,040 points. Of the 90 operators sending in scores, 62 were from the U.S. and 28 entries represented all others. The U.K. entrants were G3BXI, G3CQE, G3GNR, GM3IQL and GM8FM—in that order, G3BXI making 13,760 points to lead this section.

For the Contest, all W call areas were represented, there being stations on in 23 other "countries" (prefixes) outside the U.S. Quite an impressive result for this first international RTTY event.

That, then, is it until the April issue is due. Readers' comments (and criticisms!) are always welcomed for this column, so please write in if you have a point, or any DX news. 73 de G3CQE.

NOTICE TO RALLY ORGANISERS

It is not at all too soon to remind the organisers of this year's Mobile Rallies that we should have their dates as soon as possible now, for publication in the Mobile Rally Calendar. There is no need for full details to appear until the month before (or during which) the Rally is to be held. The important thing is to get the dates fixed, so that clashes can be avoided. If we are given sufficient notice, we can always let those concerned know if two large events are set for the same date; they can then settle between themselves whether to proceed, or change their dates. Any proposed Rally dates notified to us by February 14 will appear in the March issue.

SSB PHONE TO "CANBERRA"

First-class passengers on the new P. & O. liner *Canberra* are able to get telephone calls in their cabins through the ship's radio-telephone exchange wherever they may be, and the switchboard capacity is 30 calls an hour. During the sea trials of the ship, the Post Office tested single-sideband telephony for medium-range ship-shore working, the object being, of course, bandwidth economy with the other technical advantages that SSB brings. Four of the GPO Coast Stations—Land's End, Niton, Anglesey and North Foreland—have been equipped to work SSB to ships, using the usual phone-patch procedure to extend calls into the inland telephone system. Britain is the first country in the world to use SSB for the maritime public services at ranges up to 300 miles or so. At shorter ranges, 60 miles or thereabouts, the system goes over to VHF/SSB. The charge for a 3-min. call with the *Canberra* within 300 miles of the U.K. is 10s. 6d.; at the VHF range it is about 8s.

RTTY operators and all interested in the subject are invited to write in for this feature, the next appearance of which is in the April, 1962 issue. Photographs of RTTY stations are also welcome, and those used are paid for on appearance. Address to "RTTY Topics," c/o The Editor, Short Wave Magazine, 55 Victoria Street, London, S.W.1., to arrive by February 28.

RTTY And The SWL

SOME NOTES FOR GUIDANCE

J. B. Tuke (G3BST)

SINCE taking an active interest in amateur RTTY, the writer has received a number of letters from SWL's, asking how they can get started on RTTY reception. The majority of these have been from younger listeners, and these have proved most difficult to answer since it is necessary to be perfectly truthful and say straight out that RTTY is both moderately expensive and fairly complex (from the point of view of the beginner) and yet at the same time these are the very inquirers who must not be unduly discouraged as they are, in many cases, the amateurs of the coming generation. The aim of this short article is, therefore, to put the RTTY "cards on the table" from an SWL aspect, so that any prospective RTTY/SWL will be able to decide for himself whether to continue from the first flush of enthusiasm to the purchasing and constructional stages.

Cost

The question which is probably asked more often than any other is "How much will it all cost?" Well, the answer to that in round figures is—between £10 and £50, according to one's good luck in acquiring a cheap printer, and one's ability to make-do-and-mend with equipment which is not up to standard when purchased. This automatically leads to the question, "Where can I get a printer and how much will I have to pay for it?" There is, unfortunately, no simple answer to either part of this question—all RTTY amateurs only wish there was! The best place to look for printers for sale is probably in the Small Advertisement section of SHORT WAVE MAGAZINE. At the same time, no possible lead, however unlikely looking, should be ignored. Perhaps a local amateur might have commercial contacts—surplus dealers sometimes have printers—even scrap metal dealers have been known to produce one—so just look everywhere. When it comes to the question of price—this is likely to be between 30s. and £30, according to type of machine and condition. There are two main types of printer available—the Type 3 and the Type 7. The former produces its copy on paper strip and is not entirely compatible with modern printer code regarding figure shift and punctuation, so that, while it will be quite satisfactory for amateur QSO's, commercial broadcasts will appear full of weird hieroglyphics if the text should contain letters and figures mixed. (This is a little disconcerting when one is testing the equipment for the very first time!) For those who are interested in copying meteorological broadcasts as a sideline, this type of machine is quite unsuitable. The Type 7 produces a page copy just like a typewriter (but in capitals only, of course),

and is fully compatible with modern transmissions. Naturally, the Type 3 is considerably cheaper than the 7, and it is up to the individual to "Pay his money and take his choice"—generally within the price range quoted above.

There are also other models apart from the 3 and 7. Some produce punched tape only—others produce punched tape together with a written copy—some can make punched tape from their own keyboard, and so on. These are generally more expensive and do not have much application to SWL requirements. Some models receive only, *i.e.*, they have no keyboard. This is all right from the SWL angle, but a prospective purchaser should consider whether he is likely to need the transmission facility later.

In many cases machines purchased will be second (or seventy-second!) hand. Unless one is an engineer, it is inadvisable to purchase telegraph equipment which is badly damaged since spares are rather expensive and may be unobtainable for older models. Any equipment having bent shafting, badly worn cams or stripped gears is to be avoided unless the purchaser knows in advance that he has special facilities available for repairs, or has a source of spare parts. Make sure any machine is complete—if possible, take someone along with you who at least knows what a complete machine should look like! As with second-hand car purchase, the motto is "Let the buyer beware."

Receiver

Having settled the question of a printer, the next item is usually, "Will it work with my present receiver and what other equipment will I need?" Regarding a suitable receiver, the writer is of the opinion that serious operation of a printer from any type of "straight" receiver is not a practical proposition. It *could* be done, but more as an interesting experiment than anything else, and it could not be recommended for a beginner. Assuming then, that the receiver is a superhet, it must have a BFO and this must be adjustable in frequency. The receiver as a whole must be stable and have reasonable selectivity. Operation from an HF converter plus a standard broadcast receiver—such as is sometimes used by beginner SWL's—is unlikely to produce satisfactory results even if a BFO has been added.

However, good results can be expected from HF receivers in normal amateur use, such as the R.1155, BC-348, BC-342, AR88, HRO, and so on—and any modern communications receiver should be quite suitable.

Auxiliary equipment will consist of some form of "Teleprinter Converter," which goes between receiver and printer, and also a power supply for the printer motor. Several converter circuits are available in amateur literature, and the cost of such a unit is unlikely to exceed £10, and may be very much less according to what parts are available in the junk-box. The teleprinter motor may require 230v. AC, 220v.

You can get *Short Wave Magazine* to order through any Newsagent

DC, 110v. DC or 24v. DC, according to type. Of those available on the second-hand market, the 110v. DC type is the most common. Current requirements are about 0.5-0.75 amp. so that cost of transformer and rectifier may be in the order of £2-£3. Advertisements in any electrical or radio publication will produce results in this direction quite easily.

Know-How

Having settled all the queries about the gear itself, then comes the worst question of all—"Does it require much technical knowledge?" To answer this, the following "yardstick" is suggested: If you feel confident that you could tackle any normal electronic modification or repair to a modern communications receiver without trouble—then there is no reason why you could not take RTTY in your stride. If, on the other hand, the "innards" of a communications receiver are still a little bit of a mystery, then, to be quite fair, it would be better to leave RTTY alone for a while. It is, after all, a more advanced mode of communication, and it is better to take things in easy stages rather than be acutely disappointed in results and be bogged down in technical difficulties. Obviously a bit more knowledge is required to get RTTY going than to listen to broadcast stations on a 0-V-1.

Finally, here is a short list of common misconceptions about RTTY, all culled from letters received by the writer.

- (1) A teleprinter is *not* an electric typewriter, and in general terms cannot be used as such. It prints block capitals only, together with figures 0-9, and various punctuation and other signs—see p.312 August SHORT WAVE MAGAZINE.
- (2) Teleprinter signals are *not* high-speed Morse code—the two systems are completely different.
- (3) You cannot learn to "read" teleprinter signals by ear like Morse (apart from certain repetitive test combinations which can be recognised with practice).
- (4) Though it has been said that "Anybody can do anything," unless you are a mechanical genius (*repeat* genius) you cannot build a teleprinter!
- (5) The ordinary receiving licence covers legitimate broadcast and amateur reception—but don't copy private signals.
- (6) Where particular relays are specified in equipment, you cannot get away with using "ordinary" types. Things have to move fast in RTTY!
- (7) It would be unbearably tedious to copy RTTY signals on an undulator, and then "read" them visibly—each character has $7\frac{1}{2}$ units, and some complex timing indication would be required to show exactly when each character started and finished.

If, after reading this, you feel you would still

like to have a go, then you will find there is plenty of amateur RTTY literature from which you may glean more detailed information. There are very few SWL's reporting on RTTY, so your reports are sure to be welcome—especially if they are DX. You will be doing a really useful job in this case. If, on the other hand a sober review of the difficulties involved has made you decide to wait a while, why not try and visit an amateur RTTY station, and pick up some more gen. that way? No doubt, after a little time, you will be able to start up successfully on your own.

BOOKS FROM THE LIBRARY

We would remind readers that practically all the books we advertise (*see* p.618 this issue) should normally be obtainable on loan through the local public library—not necessarily immediately on request, but to order. If the book you want is not on the shelves, the librarian will get it for you—simply give the post-free price as advertised by us, and our address as publisher or source of supply, and it will come through in due course. Books like the *Radio Amateur's Handbook*, the *Radio Handbook* and the *Call Books* (as they come out) should be in the reference section of any large local library.

HEAD OF G.P.O. WIRELESS SECTION

The Post Office announces that Mr. R. Billington, TD, DL, M.Sc., MIEE, has been appointed Inspector of Wireless Telegraphy in the Wireless Telegraph Section, Radio Services Dept., G.P.O., to succeed Mr. T. A. Davies, OBE, who is retiring. The Inspector of Wireless Telegraphy is responsible for the control and operation of the ship-shore services; inspection of ships' radio equipment; and the examinations for the PMG's certificate for sea-going radio officers. The twelve Post Office coast stations are administered from the G.P.O. Hq. in London.

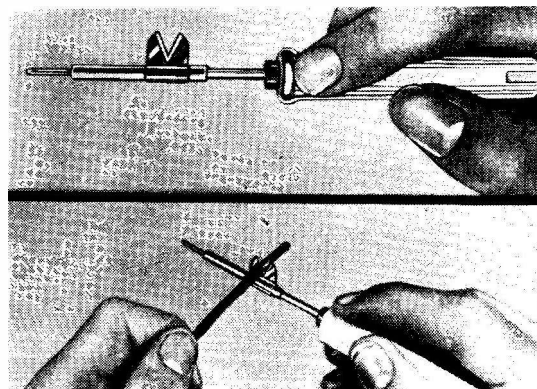

Neat wire-stripping device designed by Antex Ltd. for fitting to their standard Antex-Precision soldering irons. Heat conducted from the iron ensures that even the toughest insulation can be easily sliced off.

KITCHEN-TABLE CONSTRUCTION

IDEAS FOR PRODUCING A
NEAT JOB

W. FARRAR, B.Sc. (G3ESP)

WHEN looking over a piece of commercial equipment, or a particularly well-built home-constructed item and, being struck by the neat and precise engineering of it, one may regret having no workshop facilities wherewith to turn out gear which would be the envy of all. Undoubtedly, a well-equipped workshop is a great advantage in radio construction work, but it is by no means essential. In fact, it is possible, using only simple equipment, to achieve, with care, a high standard of workmanship. These notes are intended as an aid to "kitchen table" engineers, and are the result of several years' experience as an active radio amateur.

Marking Out Chassis

Chassis-and-panel construction is universally popular and will no doubt continue to be so. Let us assume that the apparatus to be built is a transmitter for 160 metres. The major items to be mounted on the chassis are the valve holders, audio and mains transformers, coils and tuning condensers. Take a sheet of paper and place on it these components in the positions where they are required. If all parts are not yet to hand, it is possible to use paper or cardboard cut-outs of the appropriate sizes. These parts may be shuffled about until the most convenient arrangement is decided, after which the layout should be sketched on the paper. This will give the size of chassis required. One must not forget to leave room on the front edge of the chassis for gain control, etc. (There's nothing so annoying as finding too late that the chassis is too small.)

Very good commercially-made aluminium chassis are available at reasonable prices, and it is hardly worth getting a virgin sheet of metal and trying to make one. Aluminium is recommended because it makes a strong chassis, yet is easy to work. The layout plan can now be copied on to the chassis. An ordinary pencil will mark aluminium well enough. (A scriber may be more professional but, once it has slipped or made a wrong mark, it can't be rubbed out!) Alternatively, if the paper plan is accurately made, the sheet can be fixed to the chassis by adhesive paper-tape, and punch marks for the holes made through the paper.

Tools

The following tools have been found handy at G3ESP, and are recommended:

Small and medium screwdrivers,
Spanners to fit 6 BA and 4 BA nuts, and

the nuts on volume controls, etc..

Small hacksaw, for shortening spindles, and cutting metal for making small brackets, etc.,

Fretsaw; automatic centre-punch (a great asset); $\frac{1}{4}$ -inch wheelbrace; chassis punches for valve holders; $\frac{3}{8}$ -inch hammer-type punch; light hammer; twist-drills of various sizes; round file.

Ruler—a steel rule marked down to one-sixty-fourth of an inch, and millimetres, is advantageous.

Drilling

Obviously, there must be quite a lot of drilling, so a little discussion about it might be useful. The automatic centre-punch (well worth the cost of ten shillings or so) will make its mark precisely where it is wanted. There is no risk of distorting the chassis, as there might well be if a hammer and normal punch are employed unskilfully. Having marked the exact spot, it is necessary to drill the hole at that spot—which is not always as easy as it sounds. If the drill is not held perpendicular to the work; or if the drill is blunt; or if it has been ground inaccurately, the final hole can wander anything up to one-sixteenth of an inch, which is a lot compared with a 4 BA clearance hole ($\frac{1}{8}$ -inch diameter). One way to ensure accuracy is to drill a tiny pilot hole. If one looks at the business end of a twist-drill, it will be seen that it is not pointed, but has a short, sharp straight edge at the very end. The pilot hole should be slightly greater in diameter than the length of this edge; a No. 55 twist-drill or thereabouts will do for ordinary screw holes. Having drilled the final hole, there will almost certainly be a jagged edge on the underside and a slight burr on the top side. These can be neatly removed by taking in the hand a drill of rather larger size than that which made the hole and turning it with slight pressure applied until the burr is removed.

Having been very careful, though, it still sometimes happens that a hole is slightly out of place. The answer to this is to drill the hole slightly larger than is normally recommended. For instance, the clearance for a 4 BA screw is quoted in the tables as a No. 26 drill. Using a No. 21 or 22 drill will allow greater tolerance (sometimes the component to be fixed is not perfectly in square itself).

Other Holes

The chassis punches are used for holes for valve holders, and controls which come through the panel. To make a $\frac{3}{8}$ -inch hole (for, say, a volume control) one merely follows the instructions with the tool. For a valve holder punch, a $\frac{3}{8}$ -inch hole is needed first, so the small punch can be usefully employed there. (The "washers" pushed out by either type of punch will make useful spares, incidentally.) Hacking out valve holes by any other method is laborious and very productive of masses of aluminium filings or turnings.

What about the larger holes for drop-through transformers? The writer recalls once seeing an

advertisement for an adjustable *square* chassis punch, repeated application of which, it was said, would cut out any hole above the minimum of the punch itself. It is, however, as quick to use a fretsaw. The normal woodworking blade will cut aluminium, but not easily, as the teeth are too widely spaced. A fine-toothed blade is desirable, and it has been found that a "Junior" hacksaw blade with the ends cut off and fitted into the fretsaw frame makes light work of cutting. The initial small slot could be made with a flat needle-file or with a normal fretsaw blade. The edges of the cut-out will possibly need truing-up with a fine flat file, but in any case there will be some burring of the edges. This can be removed by shaving it off with a penknife or other small blade, preferably not too sharp. This can also be used to remove the burr on a twist-drill hole.

Final Assembly

The panel of the equipment should be free from extraneous bolt heads. This can be managed in many cases by fixing the panel to the chassis by the below-chassis panel controls. If the panel is strong enough, no further support will be needed. Before assembly, a coat of paint over all visible surfaces helps the appearance, *provided it is well done*. The best way, probably, is to get the chassis and panel sprayed by the local garage. A synthetic enamel brushed on can give a good finish, but dust is the difficulty here.

The show-part of the assembly is, of course, the front panel. Why use metal? An excellent and eye-catching panel can be made from an off-cut of formica-faced hardboard, obtainable cheaply from the local do-it-yourself-at-home store (provided it is an off-cut!) However, great care is needed in drilling this material, or the surface will chip around the holes. Final trim, on commercial lines, can be in the form of a couple of strips of decorative edging as used on kitchen tables (after all, these notes are for kitchen-table engineers, as mentioned earlier!) Alternatively, the new adhesive chrome tape should be useful.

Wiring Up

There is not much need for advice here, other than to say that, with modern miniature components and compact construction (an equipment is not necessarily better because it is big), a soldering iron with a half-inch diameter bit is out of place. Satisfactory soldering can only be done with a small lightweight iron, preferably with a $\frac{1}{8}$ -inch diameter, or "pencil," bit. While such instruments will only solder lightweight items such as hook-up wire to valve holder tag, they are a joy to use, along with a good resin-cored solder, such as the Multicore types designed for the purpose. In his juvenile days, the writer, then inexperienced, used a mixture called Baker's Fluid ("killed spirits") on a receiver and wondered why the valve holder sockets turned green after a while. Such a flux, excellent for metalwork, has no place in electrical wiring. But it is still permissible to dip the iron in "Fluxite"—a tin of which will last more or less for ever—before applying it to the work!

Cabinet

Making a neat metal cabinet presents various problems, and to buy one ready-made can be expensive. What is the purpose of the cabinet? In military and commercial applications, strong steel cabinets are used largely for protection. In the amateur station the need is more for keeping the dust off the chassis and inquisitive "harmonical fingers" from the hot points. So metal is not really necessary, and a satisfactory housing can be made using hardboard and an impact adhesive. A skeleton frame can be made from square moulding, the hardboard panels stuck on, and the edges disguised by means of L-section moulding, also stuck on. For ventilation, pegboard could be used instead of hardboard where necessary. This is not, of course, the answer where screening is required, when the cabinet must be of metal.

Using Salvaged Bits and Pieces

There is no need to stress that plenty of nuts, screws, washers and solder tags are required, many of which can be reclaimed from old or ex-Service equipment. But what can one do with American screws which came out of tapped holes, and for which one has no nuts? For a small sum one can buy a tap, size 6-32, which is the common U.S. size equivalent to 4 BA, and either tap holes in a chassis (which, with aluminium, does not give too firm a fixing), or put the tap through a 4 BA nut and change it to a 6-32 nut. It *does* work!

Ex-Service units of the TU-5-B series had a nice line in aluminium sheet (forming the inner screening box) but marred here and there by screw holes. These small holes can be filled as follows: If the hole is plain, then it has to be threaded, or alternatively countersunk a little on each side (two or three turns with a suitable drill will suffice). If the hole is already threaded, all well and good. A small scrap of aluminium sheet is placed on the bench (sorry, table!) and the panel placed on it so that the hole comes on top of this piece of aluminium. Solder is then run into the hole until a blob is formed on the top. When cool, the solder can be smoothed off on both sides. When painted, the solder plug is practically invisible. Although the solder does not amalgamate truly with the aluminium, it will hold fast, due to the pre-treatment of the hole.

Final Points

It is hoped that these notes will be of assistance to constructors in making a neater job. Let it be repeated that all points made are the result of the personal experience of the writer in working with limited facilities. Although he has a cheap and nasty vice, he rarely uses it. When a third hand is absolutely necessary (the left foot already being used) he calls on the services of the XYL. But this is infrequent. Normally, two hands, one foot (the other being used to stand on) and a hip as a stop at the edge of the table, seem adequate to control the tool in use and prevent the work from moving. But a vice and clamps can be employed if available.

NOT unexpectedly, this month's report is more of a routine nature than those of the last three—conditions have been generally poor, the winter weather has made most shacks almost untenable, and the great gales in the early part of the period bent many a beam. The nett result is that very little GDX has been worked, and activity has been on the low side.

The glass has been pretty low, too—after reaching that all-time high on December 19, it went to what was very nearly an all-time low on January 11, when the reading at A.J.D.'s was 28.4 ins. Indeed, the barograph trace shows extraordinary variations during the week ending January 14, including a pronounced kick over an hour or so about midnight on January 8/9, when there were gale-force winds across Central England (and many other parts of the country as well).

Our mail still being held up, there have not been as many reports as usual this month, and accordingly it is not yet possible to decide whether the monthly barograph trace—see "VHF Bands" up to the November 1961 issue—should be continued. The few who have mentioned it have said "Yes," but the majority express no opinion, so for the time being it will be left out until we get a few more ideas.

New 70 Cm. Table

Sufficient pressure now having been exerted by those interested—which means that we have had more than the half-dozen entries required to make a start—you will observe in the bottom right-hand corner of this page a new Annual Table covering the 70 cm. band; rules as for the two-metre Annual. We hope this table will expand, and provide an incentive for all 430 mc operators; we know that there are a good many more who could put in claims. In future, this table will appear monthly, with the two-metre Annual. The other tables—All-Time Two Metre and Seventy Centimetres, Counties Worked, and the list of Firsts—will come in periodically, as movements require and space is available.

VHF BANDS

A. J. DEVON

Conditions Poor for the Period—

Increasing Activity on Four Metres—

QSO's on 23 Centimetres—

Notes, News and Comment—

Four Metres

And the 4-metre operators are now pressing for an annual table—the answer is the same as before: If we get half-a-dozen or more claims in for counties worked on 70 mc since Sept. 1, 1961, we shall be happy to start one for this band, too. Indeed, it would be a very good thing if we could, as all three active VHF bands would then be covered, and it would probably be possible to show the three columns in one panel.

Actually, things are moving well on the 4-metre band. G3JHM/A (Worthing) has now worked 25 stations in 13 counties, with G3HRP (Lincs.), G3OHN (Ches.) and G5PW (Yorks.) heard. He asks for skeds over GDX distances—*QTHR*.

G3NNO (Leeds), who normally commutes on Top Band, "having heard of the joys of VHF," as he puts it, started up on 70 mc last August, and has heard or worked 18 stations; his Rx is an RF-27 Unit into a 19 Set, and the transmitter a 12AT7 CO into 12AT7 tripler, then EF80 buffer, driving

a QV04-7 to 6w. Having started with just a dipole, G3NNO is proposing to cut a Band I TV aerial about to make something more potent; he is on after 10.30 p.m. most evenings, looking for contacts.

From Birmingham, G5JU has worked eleven 4-metre counties, running 50w. to an 815 PA and a single rotatable dipole in the roof-space; his receiver is 6AK5-12AT7 SEO into an Eddystone S.750. G3OKI (Leighton Buzzard) should be on 70 mc by about the time this appears, and will be welcome as a representative for Beds.

On 23 Centimetres

Our 1250 mc band is not very densely populated, but it has its following, and occasionally we get some news. In a very interesting letter, G6NF (Shirley, Sy.) reports as follows: "I am now operational on 23 centimetres using a CV-90 in a tripler cavity, on 1297.7 mc, CC. Using a 5-ele indoor Yagi, cross-band 23/70 cm. phone contacts were made with G3FP (Thornton Heath) and G8RW (Bromley) on January 7. Both stations have previously been heard on 23 cm. at G6NF, using an R.1294 receiver, so the next move is a two-way QSO. The R.1294 is a broad-band job and is being replaced by a 23 cm. CC

70 CENTIMETRES

COUNTIES WORKED SINCE

SEPTEMBER 1, 1961

Starting Figure, 4

From Home QTH Only

Worked	Station
14	G2FNW
11	G2CIW
10	G3KPT
9	G3JHM/A
8	G3NNG, G5UM
6	GW3ATM

This Annual Counties Worked Table is reckoned from September 1st, 1961 and will close on August 31st, 1962. All operators who work four or more Counties on the 70-centimetre (430 mc) band are eligible for entry. Counties should be claimed as they accrue, and otherwise the rules are as for the Two-Metre Annual Table

converter, the crystal chain for which has been completed. There are now five stations known to be transmitting or listening on 1250 mc." So says Alfred, and in congratulating these 23 cm. operators on their success, we hope that their experiences and results will get more people actively interested in this band.

General VHF News

G3FUR (Stamford, Lincs.) writes that "after a four-year spell off the VHF air," he got back on again in October last "just in time to miss the grand Aurora opening"—and he also mentions that he has missed all openings since! Anyway, G3FUR is able to claim for both

2m. Tables, and the refurbished gear includes a QQV03-20A PA on 145.61 mc. running 40w.; a 6/6 slot-fed J-Beam at 45 ft.; and a home-constructed triple-conversion Rx taking a 6CW4 in the RF stage. G3FUR is also going /M on two metres, with a 25w. Tx on 145 mc. and a 16-valve double-conversion receiver in course of construction.

G2CIW (Birmingham) reports a quiet spell, and puts us right as regards G13OFT, who should have been quoted as being for "Co. Down," and not the several other G1 counties he is alleged to have represented at different times. (Sorry about this, but we always quote readers' own letters, and sometimes the geography is not

very reliable!) Jack is one of the starters in the 70 Cm. Annual, with a nice total for that band.

G3OBD (Poole) reports increasing interest in 70 cm. locally, with G3NOX/T heard by G3NAE (Bournemouth). G3OBD says they hope to have five stations on the band shortly. There is no doubt that the Bournemouth-Poole area has developed a very active VHF group, inspired by G3OBB/G3OBD, and during the last twelvemonth they have shown very good progress.

EI2A (Navan, Co. Meath) says that the nightly sked with G3EHY (Banwell) continues satisfactorily, and mentions G13NFM (Pomery, Co. Tyrone) as a new station on

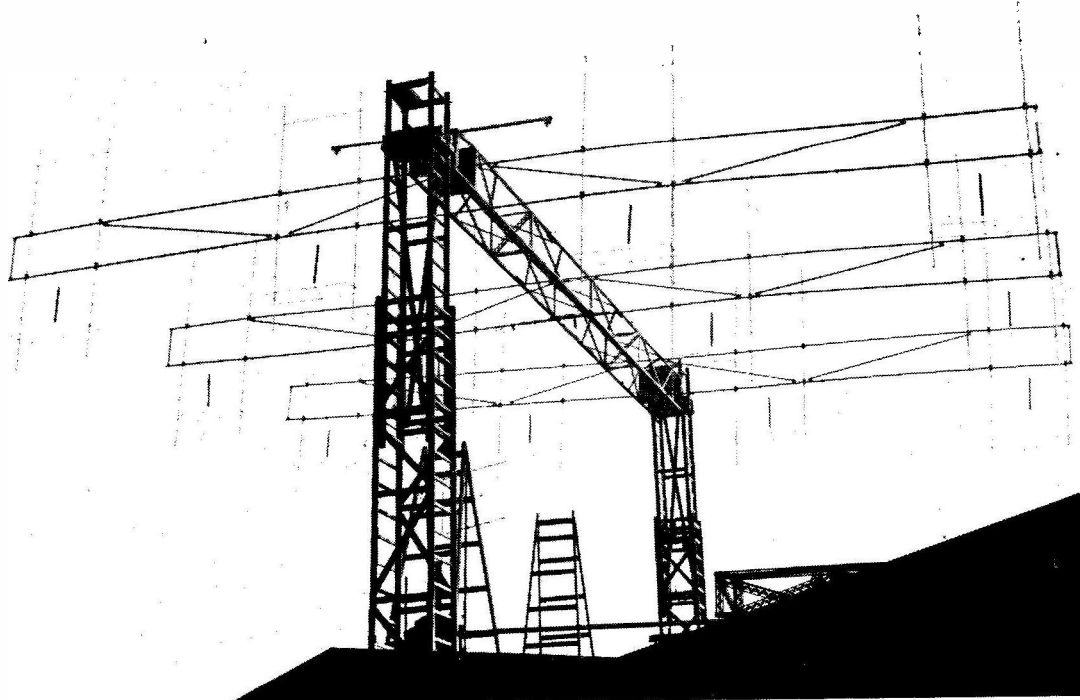

In the January issue, we were able to describe briefly the moon-reflection tests being undertaken by G2HCG, Northampton. Here is his first aerial system, consisting of 12 standard 8-over-8 slot-fed J-Beams, arranged in three bays of four each, operating on 144.32 mc. The layout of this system gave a gain of 26 dB, or times-400 in power. The beam was, of course, tiltable and also partially steerable and, with a 1 kW transmitter at the end of the feeder, produced pings off the moon in a high-gain narrow-band receiver, switched to this aerial. Alas, disaster struck on 8 January, when a violent blow of wind wrecked the whole thing, reducing it to a tangled mass, even though every precaution had been taken with extra guying. However, as explained on p.598, January, it had in any case been intended to rebuild the beam to give circular polarisation and, in fact, the work was to have been started on 9 January. Though G2HCG has had a lot of valuable material reduced to scrap, there is no intention of abandoning the project.

the band, 600 ft. a.s.l., and with a QQV06-40A in the PA; EI2A says he should be a very good signal when he gets organised—and he will be in great demand, for one of the rarer GI counties. Other stations expected on in due course are EI6W (Galway), EI6X (Limerick), EI7D and EI9V (Dublin).

GW3ATM (Chepstow) and G5QA (Exeter) keep it up on 70 cm., with thrice-weekly skeds that "have never failed yet"—even with the 12-ele stack thickly coated with ice. GW3ATM now has a straight PA on 430 mc, with improved reports from G5QA. Herbert himself also writes, to correct his table positions.

Always active and covering

SEVENTY CENTIMETRES

ALL-TIME COUNTIES WORKED

Starting Figure, 4

Worked	Station
37	G2XV
30	G6NF
28	G3HBM
27	G3JWQ, G3KEQ, G3NNG, G5YV
26	G2CIW, G3JMA, GW2ADZ
25	G3HAZ
24	G3LHA
23	G3BKQ, G3KPT, G6NB
21	G3IOO
20	G3LTF
17	G3MPS
16	G2DDD, G3JHM/A, G3MED
15	G2OI, G4RO
14	G2HDZ, G3FAN, G3LQR
13	G3BA, G6XA
12	G5BD
11	G3AYC, G5UM
10	G3IRW
9	G5DS, GW3ATM
7	G2HDY, G3JHM
6	G3KHA, G3WW, G5QA
5	G3FUL, G3HWR, G3IRA, G3IUD, G3JHM, G5ML
4	G3JGY

On working four Counties or more on the 70-Centimetre band, a list showing stations and counties should be sent in for this Table, and thereafter new counties worked notified as they accrue

three VHF bands from his /A station near Worthing. G3JHM has been pushing the scores along on 2m. and 70 cm., mentioning G3MNQ (for Notts.) and G3CCH (Lincs.) as worked on the latter band. He asks for schedules on 70 cm. with the Midlands and the North.

G3CO (Hartley, Kent) caught the recent openings, and moves in the Annual thereby; he heard what was probably one of the last "Oscar" transmissions, on January 1; surprisingly enough, we have had no other comments about Oscar this time. G3IOE (Newcastle) writes that he is getting organised at a new QTH—300 ft. a.s.l., on a hillside, but the screening is to the west and south-west (so G3IOE wonders if he'll be any better off for GDX).

G3OHD (Petts Wood) has now got a new Tx going with very satisfactory results—it consists of the first three stages of the design described in the September 1958 SHORT WAVE MAGAZINE, followed by the two final stages of the design in our June 1956 issue; this enables a QQV06-40A to be run at about 90-100 watts input. G3OHD has got his foot on the Counties ladder, GC2FZC giving him the 8th country required for a start in that table.

We have several claims on hand for the VHFCC Certificate, and these will be cleared in time for the next issue. As a matter of policy, we have been holding up a bit on certificate claims, due in the first place to the Christmas delays, and secondly to the prevailing postal disorganisation—and we would advise readers to do the same until the mails return to normal.

In case it needs saying again: The VHF Century Club Certificate is awarded to those who can prove, by showing the cards, that they have worked 100 stations two-way on any VHF band from 50 mc upwards; claims should be sent by registered post, attention A.J.D., with a *check list*—this latter is essential—together with some notes on gear used, scope of activity, and since when on VHF. In the last twelve years, more than 300 VHFCC Certificates have been awarded; all are notified in this

TWO METRES

COUNTIES WORKED SINCE SEPTEMBER 1, 1961

Starting Figure, 14

From Home QTH Only

Worked	Station
55	G5MA
52	G2CIW
43	G3KPT
40	G3NNG, G8VZ
39	EI2A
38	G3OJY
36	G2AXI
35	G3CO
34	G5DW
31	G3FUR, G13ONF
24	G5QA
22	G3PBV
21	GW3MFY
20	G3GSO, GW3ATM
19	G3JWQ
18	G8VN
17	G3LTF, G3OBD, G5UM
15	G3FIJ, G3OSA

This Annual Counties Worked Table opened on September 1st, 1961, and will close on August 31st, 1962. All operators who work 14 or more Counties on Two Metres are eligible for entry in the Table. QSL cards or other proofs are not required when making claims. The first claim should be a list of counties with the stations worked for them. Thereafter, counties may be claimed as they accrue. Note: While new claims can be made at any time in the period from now to end-June 1962, all operators are asked to send in amended scores as often as possible, in order to keep the Table running up-to-date. After June 30, 1962 (with two months still to run to the end of the 12-month season), only amended scores from those already standing in the Table at that date will be accepted, unless they are new claims from operators licensed w.e.f. June 1962.

feature. A variation is the /M endorsement—for conditions see p.320, August issue.

In Conclusion—

And that winds it up for this month. For the March issue, all correspondents are asked to get their reports and claims in by **February 14** latest—addressed A. J. Devon, "VHF Bands," *Short Wave Magazine*, 55 Victoria Street, London, S.W.1. It won't be long before we meet again, on March 2, all being well. 73 de A.J.D.

AMATEUR MICROWAVE EQUIPMENT

ASPECTS OF DESIGN — STATION LAYOUT — APPARATUS TO USE

Part I

D. CLIFT (G3BAK)

The author of this article has done much practical work on the amateur microwave bands—centimetre wavelengths—and has designed a range of equipment which can be either home-constructed or contrived from items in the surplus category. The plumbing is easier than it looks, accuracy of dimension being the important factor, and some of it is commercially

WITH the advent of new microwave bands in May 1961, and the hope of increased amateur activity on them, for the writer the time had come to consider carefully the question of the re-design of equipment which had been in use at G3BAK for two or three years. It is the purpose of this article to discuss the various factors influencing the design of amateur microwave gear, and to describe a new set of equipment, which should cater for operation in all these bands for the next several years.

For the benefit of those of us who have not looked closely at our licences recently, the microwave bands at present available to amateurs are as shown in Table I. Operation on them does not, of course, produce large numbers of contacts, but does result in the gain of much useful information and practical experience which, to the writer's mind, cannot be obtained in any other way. Up to the present, operation at G3BAK has been more or less confined to the 10,000 mc band (3-centimetre) starting in about 1953. During this time the main aims were to keep the gear simple and portable, but during the last few months it has been realised that a complete reversal of this policy was necessary in order to be able to co-operate with any other amateurs trying any of the UHF/SHF bands.

Operation at these frequencies immediately brings us into conflict with such things as waveguides and klystrons.

available. There is now an extensive literature on microwave technique, and much of it is applicable to amateur operation on the microwave bands—of which there are several available for AT stations. Though communication is possible mainly over line-of-sight paths only, considerable distances can be covered by choosing suitable sites on high ground, and there is much scope for experimental work over local distances.

—Editor.

Some knowledge of them is essential and, in order to put the reader in a position to follow the discussion, a brief introductory note may help with some of the practical aspects of these two subjects.

Waveguide Systems

The choice of either a coaxial or a waveguide system is governed by a large number of factors. As far as we as amateurs are concerned, two points really matter, *i.e.*, as the frequency gets lower, the size of the guide gets larger, and more inconvenient; and as the frequency goes higher, the design of the coaxial gear gets more difficult. Therefore, we find that, in order to cover all the bands available to AT stations, we start off at the low frequency end in coaxial, pass through a region where a mixture of both is suitable, and finish up at the higher end of the range in a waveguide system.

In Table I also are listed the type of transmission system recommended for use in the various bands, together with the (inter-Service) waveguide size chosen by the writer. It should be realised that the operation of a waveguide system depends upon nothing magical,

TABLE I
AMATEUR FREQUENCY ALLOCATIONS ABOVE 144 Mc
As from May, 1961

FREQUENCY <i>Megacycles</i>	WAVELENGTH <i>Centimetres</i>	RECOMMENDED MEANS OF TRANSMISSION	WAVEGUIDE SIZES <i>Inside dimensions, in inches</i>
420—450	71.38 — 66.62	Coaxial	—
1215—1325	24.67 — 22.63	Coaxial	—
2300—2450	13.03 — 12.24	Coaxial; also WG8 made from tin-plate	WG 8: 4.300 x 2.150
3400—3475	8.82 — 8.63	Coaxial; also standard WG10 and (WG11)	WG10: 2.840 x 1.340 WG11: 2.372 x 1.122
5650—5850	5.31 — 5.12	WG14 (WG12)	WG12: 1.872 x 0.872 WG14: 1.372 x 0.622
10,000—10,500	2.998 — 2.855	WG16 (WG15)	WG15: 1.122 x 0.497 WG16: 0.900 x 0.400
21,000—22,000	1.428 — 1.363	WG20	WG20: 0.420 x 0.170

- NOTES: (1) The first three are not strictly "microwave," but are included for comparison.
 (2) The total frequency area allocated to amateurs in the range shown is 2065 mc.
 (3) Waveguide (WG) sizes in brackets in Col. 3 are second choice.
 (4) Coaxial fittings for all but the first (430 mc) band should be BNC Type N, or Type C.

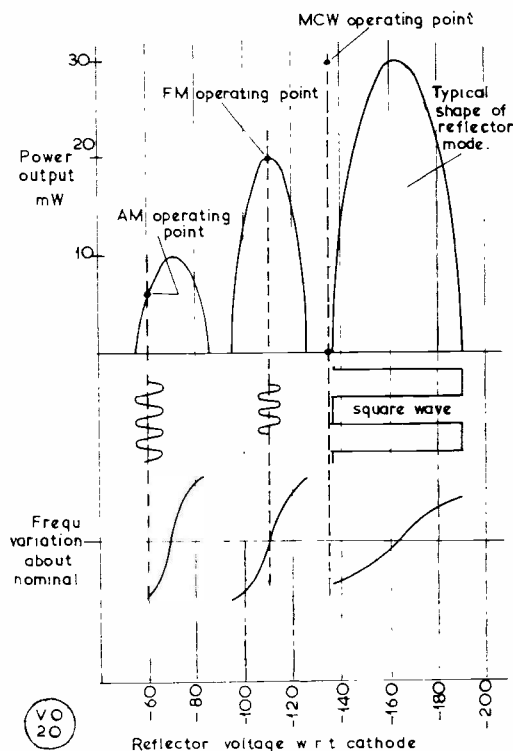

Fig. 1. Typical klystron characteristics, showing modulating operating points. In the equipment used by G3BAK, the klystron plays an essential part.

and once one has spent a couple of hours or so studying some of the more simple discussions on the subject, the whole aspect of operation on these fascinating bands becomes quite straightforward. It should also be remembered that to buy the basic materials such as tube and flanges is no more expensive than buying valves and components for the HF DX bands. Some useful practical references are given in the Appendix: (1), (2) and (3).

Klystrons

At the lower end of the spectrum in question, use of semi-conventional valves is still quite in order, but as we get past about 3,000 mc (10 centimetres) the reflex klystron is really the only satisfactory means of generating a usable amount of power simply. The reader is referred to the many excellent books on the subject of the operation of these devices, and a brief note is added below to show how they are used in the amateur field. Unfortunately, new valves of this nature are rather expensive, but luckily several types which can easily be made to work in the amateur bands are available at low cost on the surplus market.

The methods of modulating the klystron are illustrated in Fig. 1. Some of the characteristics of this type of valve are shown and, for clarity, a different method of applying modulation is given for each of three reflector "modes." In practice, of

course, only one of these types of modulation is used on one of the modes at any one time.

MCW or tone CW is obtained by the application of a square-wave of the order of 50 volts peak-to-peak, so as to sweep through one mode, but not to run into adjacent ones. The frequency of the modulation is normally between 1000 and 3000 cycles, to produce a musical note, and when a klystron is modulated in this manner, the demodulated wave is useful in a great number of ways. In the case under discussion, of course, it is keyed for the Morse transmission.

Frequency-modulated phone is obtained by applying an audio frequency of a few volts amplitude to the peak of the reflector mode. As will be seen from the lower half of Fig. 1, there is a choice of deviation for a constant-amplitude audio input.

Speech by AM is obtained (always together with some residual FM) by adjusting the nominal reflector operating point to be on the slope of the mode, and by using a slightly larger audio signal than for FM; for AM, a carbon microphone, working through a transformer straight into the reflector lead, is all that is required. In the MCW case, a single 12AT7 multi-vibrator, running at a low voltage, is sufficient. A point worth noting at this stage is that, just as it is possibly easily to modulate the valve by speech, so it is also very easy to produce unwanted AM and FM from hum and ripple. These must be eliminated entirely if any reasonable results are to be obtained.

Station Arrangement

The technique most frequently used for amateur microwave communications is illustrated in Fig. 2. The equipment at *Station A* consists of one modulated reflex klystron oscillator, operating at, say, 10,000 mc; a mixing device to couple together the incoming and outgoing signals in the correct proportion, feeding an intermediate amplifier at, say, 45 mc; then an output stage, power unit and aerial system (which can be either a horn or parabolic dish with radiator) to complete the assembly. *Station B* has similar gear, but operates its reflex klystron on 10.045 mc, i.e. the intermediate frequency away from *Station A*. This requires, of course, that for two-way communication (which very conveniently happens to be duplex) the intermediate frequencies must be identical. It will be noted that a low frequency communication link is included in the layout, as a talking channel to help in establishing contact.

Since operation on these frequencies is normally limited to line-of-sight paths—which can be over considerable distances—portable operation is usually

SUITABLE IF/AF AMPLIFIERS

- 30 Mc — APQ43 Unit, with AFC strip and balanced input pre-amp., or home-built single-ended cascode pre-amp. (American).
- 45 Mc — Receiver Unit 218, A.M. ref. 10P/16043, and FM frequency control unit Type 27, A.M. ref. 10D/18623, ("Pye IF Strip").
- 60 Mc — Units Type APX6 or UPX6, with added WE-D150980 FM detector strip, consisting of 2/6AC7's, 1/6H6, 1/6SQ7. (American).

Note: The circuit diagram Fig. 3, to appear in the next issue, shows an early version of the Pye 45 mc IF strip, with output stage modifications.

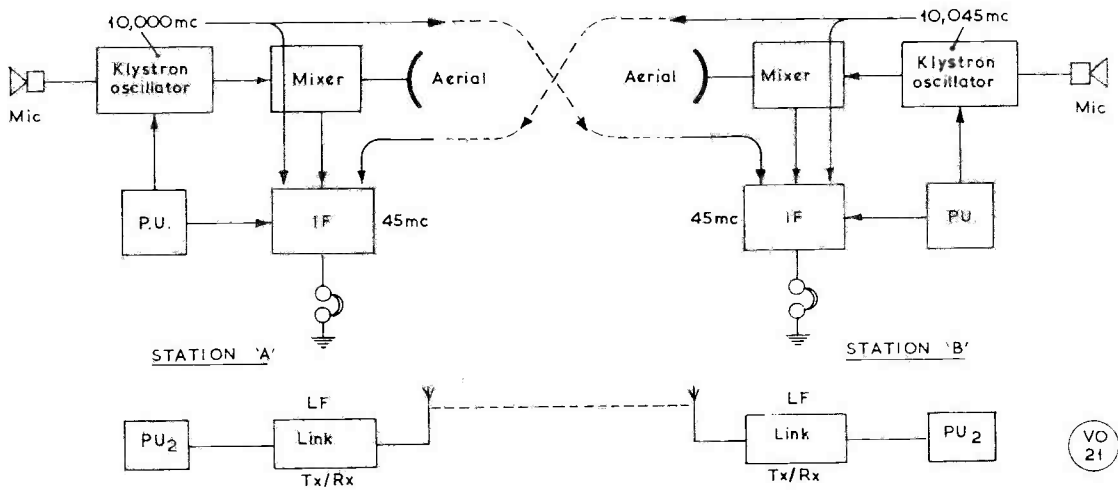
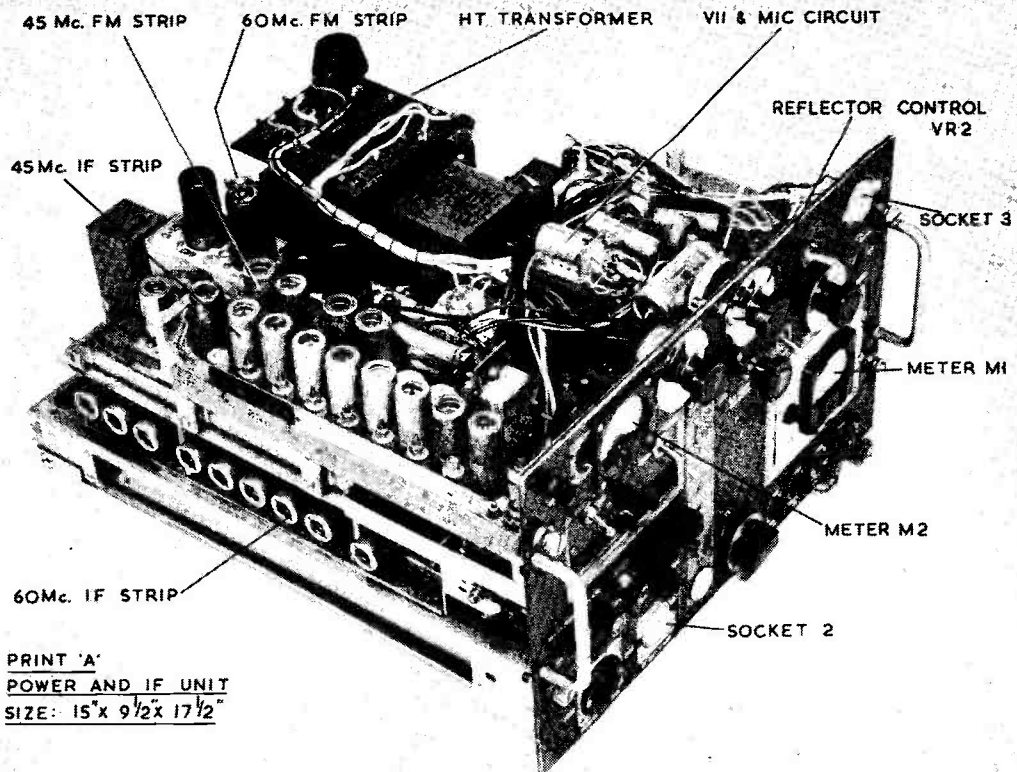

Fig. 2. Recommended method of communication at microwave frequencies. This represents a complete set-up, with the SHF side working both ways, using the difference frequency between the klystrons as the IF common to both. Assuming a pair of stations many miles apart, it is always convenient to have a talking link on some lower frequency band merely for the purposes of checking availability, fixing the SHF schedule and adjusting the directivity of the SHF aerials. Once the SHF side has been set up to work correctly, the LF link can be discarded, as signal strength will usually be much better on the microwave circuit.



The power and IF unit assembly used by G3BAK for his microwave work, with main items identified. For reasons explained in the article, the associated station uses the same IF, so it is convenient to duplicate the equipment. Some suitable surplus IF/AF units are listed in the table opposite.

required for all but the most local contacts. This immediately begins to present some problems, some of which, at G3BAK, have been:

- (a) On the supply side, the policy in the immediate past has been to have a dual-purpose unit, which would switch from either a dynamotor fed from a car battery or to a mains supply. The design was started from the dynamotor output, which had to feed some form of stabiliser for the klystron, followed by the intermediate frequency and other stages. The latter were rated as conservatively as possible in the interests of power economy. The mains supply was then arranged to feed approximately the same voltage into the units and, in addition, some part of the HF-band link was usually mixed up in the arrangement. Considerable difficulty was experienced in matching up the HT's from the alternative sources at different loads. The VR-tube stabiliser bank, with its wasteful dropper for the intermediate frequency amplifier, etc., were also constant problems and never really satisfactory.
- (b) On the waveguide side, the use of a twin-dish system offered increased efficiency and easy electrical design, but always gave trouble because of the accurate mechanical alignment necessary and from the effects of the wind; this system has been dropped in favour of a single dish, as large as possible, and the use of what is known as a "3 dB coupler" as part of the mixing element.
- (c) The choice of the HF-band link frequency requires some careful thought, and agreement with fellow-workers is essential. In the light of experience, a reliable link and careful planning are absolutely necessary, if any positive results are to be obtained.

THE DESIGN OF A SPECIFIC SET OF EQUIPMENT

In this set of equipment the design was governed by the following factors:—

- (1) Since many Radio Clubs and similar organisations now possess, and are willing to loan out, a petrol generator set giving 240v. 50 c/s AC output, the main power unit should operate from this supply only. In addition, electronically stabilised supplies for the klystron should be derived from a series stabiliser and DC amplifier arrangement, and should be separate from the supplies to the IF and other stages.

- (2) That the klystron power unit mentioned here should be suitable for use with low voltage klystrons only, *i.e.* those operating with cavity voltages of the order of 300v., and that the supply should be arranged so as to have the choice of either positive or negative line earthy. This is because some types of klystron have the cavity (anode) connected to the outer metalwork and thence to the waveguide system.
- (3) That, in order to offer compatibility with almost any fellow-operator, intermediate frequency units for 30, 45, and 60 mc must all be available, and that all should be capable of either AM or FM reception.
- (4) That a 3 dB coupler system be used in all bands above 2.300 mc. This gives the simplest waveguide system, easily produced from standard tubing with the tools found in any amateur's shack, and allows a single aerial to be used in a duplex system.
- (5) That the LF links be completely separate, and still retain their feature of portability from car battery supply. A range of communication frequencies should be provided, to fit in with fellow-workers; at G3BAK at present 160, 80 or 40m. from an unmodified TCS system, a mobile 2-metre station, and a portable 70 cm. station are available. These may be used for such important jobs as preliminary survey work over a proposed path, and the actual communication necessary before and during a microwave contact.
- (6) That dry battery power be retained initially for supplying the additional element of the klystron (the reflector), in order to simplify the power unit and assist in the reduction of the unwanted modulation referred to in the introduction. It is intended, however, to replace this feature by a mains-operated unit in the near future, after any other operational snags have been cleared.

To be continued

ALMOST BEYOND BELIEF

During the last month or two, we have had three authentic cases of people, writing in for "New QTH's," who have given their own addresses incorrectly. These priceless examples of mental aberration have been carefully filed—it may be necessary to produce them in evidence, some time!

NEW QTH's

This space is available for the publication of the addresses of all holders of new U.K. callsigns, as issued, or changes of address of transmitters already licensed. All addresses published here are reprinted in the U.K. section of the "RADIO AMATEUR CALL BOOK" in preparation. QTH's are inserted as they are received, up to the limit of the space allowance each month. Please write clearly and address on a separate slip to QTH Section.

- DL2AB**, D. A. Bowden, 205 Signal Squadron, B.F.P.O. 24.
- G2QK**, D. V. Briggs (*ex-G2QI*), Fernham, Bath Lane, Fareham, Hants. (*Tel.: Fareham 4128.*)
- GI3OZX**, J. T. Grier, 44 Woodvale Park, Dungannon, Co. Tyrone.
- G3PAD**, Paddington and District Amateur Radio Society, c/o N. A. Lambert, 2 Warwick Crescent, London, W.2.
- G3PEK**, B. D. Simpson, 48 Moorland Road, Woodsmoor, Stockport, Cheshire.
- G3PFN**, J. Neal, 217 Sladfield Road, Ward End, Birmingham, 8.
- GM3PGH**, F. Black, 43 Graffham Avenue, Giffnock, Glasgow.
- G3PHC**, Painton Radio Club, Painton & Co., Ltd., Bembridge Drive, Kingsthorpe, Northampton.
- G3PLH**, J. P. Davies, Farfield, Holt, Norfolk.
- G3PLI**, W. D. N. Berry, 4 Falcon Road, Bingley, Yorkshire.
- G3PLL**, R. P. Moore, 6 Hayes Road, Clacton-on-Sea, Essex.
- G3PMP**, J. M. Crosland, 2 Raw Nook Road, Salendine Nook, Huddersfield, Yorkshire.
- G3PMT**, J. S. Russell, Room C-6, Garland Block, R.A.F. Station, Scampton, Lincoln.
- G3PMV**, A. J. Feist, c/o Sgts' Mess, R.A.F. Station, Scampton, Lincoln.
- G3PNF**, D. A. Bowden (*DL2AB*), 48 Glenville Road, Yeovil, Somerset.
- G3PNM**, P. D. Smith, 19 Horsforth Avenue, Bridlington, E. Yorkshire.
- G3PNM/A**, P. D. Smith, Welbeck College, Worksop, Notts.
- G3PNS**, R. Simmons, 62 Daneville Road, Liverpool, 4. Lancs.
- G3POA/A**, N. F. Addison, Hannah Block, Electronics Centre (G.R.S.F.), R.A.F. Station, Scampton, Lincoln.
- G3POH**, K. J. McLennan, 39 Limmer Lane, Felpham, Bognor Regis, Sussex. (*Tel.: Bognor Regis 3078.*)
- G3POJ**, A. Perkins, Spring Terrace Gardens, Nuthall, Notts.
- G3POQ**, P. D. Hayes, Hilltop, Vines Cross, Horam, Sussex.
- G3POR**, E. Lewis, Glanrhyd, Weavers Hill, Wisborough Green, Billingshurst, Sussex. (*Tel.: Billingshurst 387.*)
- GI3POS**, A. G. Smyth, Drugmask, Lurgan, Co. Armagh.
- G3POV**, B. C. Wright, 10 Mornington Avenue, Bromley, Kent. (*Tel.: RAV 0741.*)
- G3POZ**, D. Lane, 60 Greenland Crescent, Southall, Middlesex. (*Tel.: SOU 4893.*)
- G3PPB**, J. M. Perkins, 20 Durrant Road, Parkstone, Poole, Dorset. (*Tel.: Parkstone 3467.*)
- G3PPE**, M. J. Eccles, 8 Kelmscott Drive, Wallasey, Cheshire.
- G3PPF/T**, P. A. Schorah, 1 Groveland Avenue, Wallasey, Cheshire. (*Tel.: NEW Brighton 4783.*)
- GM3PPJ**, H. Hogg, 35 Glen Avenue, Logan, Cumnock, Ayrshire. (*Tel.: Cumnock 2148.*)
- G3PPK**, M. B. Everley, Peel House, Fairfield Road, Uxbridge, Middlesex. (*Tel.: Uxbridge 36989.*)
- G3PPP**, A. A. George, 332 Main Road, New Duston, Northampton.
- G3PPR**, J. R. Beavon, 129 All Saints Road, Kings Heath, Birmingham, 14.
- GW3PPS**, A. E. Cook, 45 Highfield Crescent, Aberargoed, Bargoed, Glam.
- GW3PPW**, J. Whitehill, 10 Channel View, Risca, Newport, Mon.
- G3PQG**, N. F. Cutter, c/o Officers' Mess, R.A.F. Station, Topcliffe, Thirsk, Yorkshire.
- G3PQL**, L. M. Holyhead, 3 Arnold Road, Tottenham, London, N.15.
- G3PQN**, S. W. Walbridge, 4 Rectory Cottages, Church Lane, Fawley, Southampton, Hants. (*Tel.: Fawley 209.*)
- G3PQO**, J. L. Collins, 49 St. Clements Drive, Bletchley, Bucks.
- G3PQQ**, A. J. Wilkes, 141 Overlade Crescent, Coundon, Coventry, Warks.
- G3PQR**, P. J. Reynolds, First Green, Thorpe-le-Soken, Essex.
- G3PQS**, A. Christopher Stead, 78 Beckett Park Drive, Leeds, 6, Yorkshire.
- G3PQV**, E. R. Hodgson, 12 Phillimore Street, Lees, Oldham, Lancs.
- GI3PQW**, W. Campbell, 7 Silverstream Park, Bangor, Co. Down.
- G3PQZ**, C. H. Jarvis, Belmont, Ulverston, Lancs. (*Tel.: Ulverston 2158.*)
- G3PRK**, A. H. Yilmaz, 129 King Edward Road, Hackney, London, E.9. (*Tel.: AMHerst 0653.*)
- G3PRR**, R. J. G. Stevens, 12 Huxley Sayze, Great Cambridge Road, London, N.18. (*Tel.: PAL 3723.*)
- G3PTC**, D. Byrne, Peterborough Technical College, Eastfield Road, Peterborough, Northants.
- G5IC**, L. F. Ivin (*ex-G5IV*), B.B.C. Station, Ludlow, Shropshire.

CHANGE OF ADDRESS

- G3ENZ**, A. Johnson, 2 Browning Close, Arnold, Nottingham.
- G3JBA**, G. H. Maddox, 72 Durnsford Road, Wimbledon, London, S.W.19.
- G3MCY**, G. C. Moore, c/o Officers' Mess, R.A.F. Station, Stradishall, Newmarket, Suffolk.
- GM3NVU**, G. A. MacLauchlan, 16 Wellpark Terrace, Bonnybridge, Stirlingshire.
- G3OKR**, C. A. Adamson, 36 Esmond Road, Kilburn, London, N.W.6.
- G3OMU**, A. Bradbury, 1 Reading Road, Basingstoke, Hants.
- G5IJ**, I. J. P. James, 11 Corringway, Ealing, London, W.5. (*Tel.: ALPerton 1237.*)
- G6IB**, H. N. Miles (*ex-GM6IB*), 11 Orleans Street, Buttershaw, Bradford 6, Yorkshire.

THE OTHER MAN'S STATION

G3MAY

THE station operated by G3MAY—H. F. Stenhouse, now at 11 Hanover Road, London, N.15—first came on the air in October 1957, the QTH at that time being in the E.17 district of London. A start was made with a CO-PA arrangement taking a 6V6 driving an 807, on 40-metre CW, with which a fair share of DX was worked; the receiver was an SX-24, and the aerial an end-fed wire about 60 ft. long. The CO-PA rig gave way to an ex-Army 36 Set, modified to work on the 10-15-20-40 metre bands, with which G3MAY's scope was considerably extended.

In the spring of 1959, a move was made to the present QTH at Tottenham, London, N.15. This had many advantages over the Walthamstow location: First, a proper shack was available, out in the garden; and secondly, there was more aerial space. Mains power was laid on to the shack, which was lined throughout with hardboard backed by copper gauze, with a fibre-glass packing behind the gauze.

By November 1959—to give an added incentive to the xyl. May (*not* a coincidence; as always, the G.P.O. was most co-operative)—phone operation was commenced with a series-gate modulated transmitter firing on Top Band. Having whetted the xyl's appetite for Amateur Radio, a certain amount of financial latitude was then forthcoming! At any rate, the station now runs as the main item a Heathkit DX-100U transmitter, with a Philips BX-925A receiver. (It would be interesting to know if any other U.K. amateur uses such a receiver?). A novel feature of this Rx is motorised tuning.

The present aerial system consists of 20-40m. dipoles fed by a single 75-ohm balanced line through a balun; a 30-ft. vertical wire which can be resonated on any band 10-80 metres by base loading; and a "long wire," which can be made to radiate on Top Band. The aerial system incorporates an SWR indicator.

G3MAY has now been organised for RTTY on the HF bands, using a Type 3X printer and a suitable

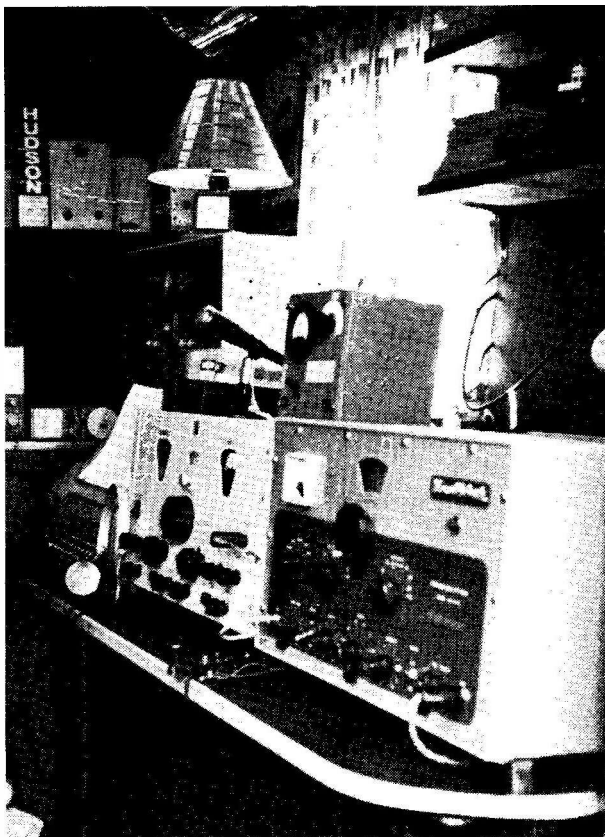

terminal unit. Auxiliary equipment includes a Heathkit GDO, valve voltmeter and crystal calibrator, also a combined modulation monitor/field strength meter.

At G3MAY, the working of DX as such is not a serious interest, because "if you stand on the same street corner long enough, everyone will pass by in due course." Apart from that, no particular point is seen in working from Tottenham to Timbuctoo on a tetrode—the language is not always understood, anyway! Rag-chewing and general chatter is enjoyed, even if after a hard day in the office one doesn't feel inclined to delve too deeply into the technicalities.

G3MAY and his xyl (May), in the true amateur tradition, keep open house for all interested in Amateur Radio, and are always glad to see the locals, particularly the beginners struggling to master Morse—G3MAY remembers his own early days in the Royal Signals.

The QSL policy at G3MAY is 100% on first contacts only—and as May keeps the record, any complaints should be referred to her! Summer-time interests include going round the Rallies, and during the last season they were seen at Harlow, Longleat, Barford, Stamford, Luton and Woburn Abbey—which is as good a record of attendance as anyone could show.

ANOTHER MAN'S SHAMBLES

ON quite another note, we show (with some reluctance and a great deal of doubt) the station attributed to G3LSD—said to be owned and operated by Lt./Cdr. Ellis Diggle, VRD, of Collingwood House, Stoke Damerel, Plymouth, Devon—who says he is probably the only amateur in the U.K. who operates from what was formerly a bishop's palace. Having tidied-up the shack a bit, he thought he ought to send us a photograph. Here it is.

The place being in what G3LSD says is "the usual indescribable mess," he finds it hard to give us what is called the run-down. But in spite of that (and we believe him), we are assured that he can make it go on any band from 10 to 160 metres—though the AR88 is ex-cabinet and the K.W. "Vanguard" (modified for Top Band) should have a little more ventilation. The other various things lying about are fairly obvious, but we still don't know how he gets into the middle of that complex. The motor-horn is not only an ornament; it is used to identify to the locals when working on Top Band. The bottle of nourishing liquor, placed rather obviously in the foreground, is the local brew that has been drunk in every R.N. ward-room from Plymouth to the River Plate for at least the last one hundred years.

In case you think we are not being serious, G3LSD is fortunate enough to be a staff communications officer in the R.N. Reserve, and in the recent past his training spells as a volunteer reservist have taken him



on sea-going trips to Gibraltar, Malta, Norway and the ports of Holland, North Germany and Finland. This has given him the opportunity to make personal QSO's with a large number of foreign amateurs. G3LSD is, of course, a member of the R.N. Amateur Radio Club and is also senior vice-president of the Plymouth Radio Club.

(Editorial Note: It is well realised that this unusual offering is due to the paragraph that appeared on p.537 of the December issue of the Magazine. It teaches us to be a lot more careful!)

UNGOOD SWL REPORTS

G3GJQ (9 South Avenue, R.A.F. Swanton Morley, Norfolk), who is QSL manager for the Kamaran Is. DX-pedition reported in the December issue of *SHORT WAVE MAGAZINE*—and, indeed, was one of the operators on VS9K—writes as follows: "Of the many SWL reports received, less than 1% are considered of real value . . . the main criticism is the brevity of most of the reporting . . . with the advance publicity and the 'pile-up' as a marker, the mere fact of *hearing* the station is of no consequence . . . some SWL's could not even list the stations being worked! If a period report is impracticable, then a report of signal strength variation over, say, one hour, would

indicate some diligence . . . On the other hand, an example of excellent SWL work was a 40m. report which showed we were being heard in the U.K. when only W's were audible with us; another was an SWL report detailing the CQ's we made on 80m. without reply . . . But to be told we were 579 in QRM whilst handling a 20m. pile-up of 100 stations deep and 50 kc wide was ludicrous, to say the least . . . however, the standard of U.K. reporting was higher than most of the EU's, except only the Swedish reports, which were markedly good . . . with about 5,000 cards to handle, a QSL manager appreciates an s.a.e., either with stamps or IRC's." G3GJQ has brought out points which will interest many SWL's (and may give others something to think about).

THE MONTH WITH THE CLUBS

By "Club Secretary"

(Deadline for March Issue : February 9)

(Address all reports for this feature to "Club Secretary")

DESPITE the inevitable delay of certain Club notes in the post, we have received at least the usual quota this month, some being held over from last month, when, despite the announcement that they were not wanted, quite a number did arrive. Where they made any reference to future programmes they have, of course, been incorporated in this report.

The annually-recurring disease known as "post-MCC Blues" has been in evidence; quite a few contestants have discovered that if they had worked just a *little* harder, or if the operator had gone without just one cup of tea, they would have been three or four places higher up the table.

From one club, who did very poorly in this event, comes the suggestion that it should be a monthly affair! They obviously want to get in some practice. Meanwhile, back to routine, and plenty of activity reports to summarise:

Aberdeen held an AGM and heard that they were in a very satisfactory state, both financially and numerically. On February 9 they are having a Junk Sale (although they call it a "Grand Sale of Radio Equipment and Components"); and the 16th is "Top Band Night," when members are invited to bring their rigs along, put them on the air, and invite reports from another nearby Club.

British Timken held a post-MCC discussion and have chosen from our back issues a suitable transmitter to build for next year's event. Their present station is on Top Band every Tuesday evening and works /M members to and from the Club. Contacts welcomed, 1925 kc, from 1930 onwards, with G3NIB.

Bradford are having a field day discussion and informal meeting on February 13, and a display of members' gear on the 27th. **Burton-upon-Trent**, now on the air with the call G3NFC, have a talk on Timebases on February 14, by Mr. A. Bailey.

Burnham-on-Sea, who have been going now for six months, meet on the second Tuesday at the Crown Hotel at 7.30 or 8 p.m., depending on the nature of the meeting: the January meeting took the form of field day discussions, and the February event will be a recorded lecture.

Crystal Palace will be holding their annual Morse Class and so on at the QTH of G3IIR on February 5; Saturday, February 17, is the date for their AGM. **Derby** report that their membership has now passed the 150 mark—this must make them one of the largest Clubs in the country. They are holding their AGM on February 7 and the Annual Dinner on the

17th. At the regular meeting on the 14th G3NGV will open a discussion on Reflectors.

East Kent, after winding up January with a Junk Sale, will be hearing a talk on SSB from their secretary, G3MDO, on February 6; they are running R.A.E. classes, with slow Morse "coming up." **Enfield** will hear a talk on Power Supplies (by G3IWA) on February 22.

Halifax hold their Annual Dinner on February 6, and a ragchew on the 20th. **Midland** will be hearing a talk on Eddystone receivers (by a member of the firm) on February 20.

Peterborough members had a special Christmas treat when they were invited to tour the local BBC station at Morborne; they are making good use of both Morse and R.A.E. classes at the Technical College, and their forthcoming meetings include a Film Show (February 2) and a talk on Aerials (March 2).

Plymouth recently held the competition for the Hillyard Trophy, and first prize went to John Fallon (7-valve communication receiver); second to Roger Smith (Oscilloscope) and third to Michael Smith (Voice-operated Relay). This was followed by an exhibition of home-built gear by the transmitting members, and a talk on Erection of Beam Aerials by G3OKA. On February 7 they will be discussing field day arrangements.

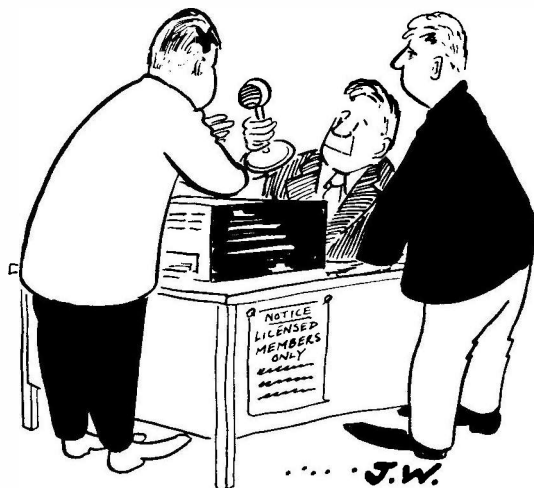

Purley have an unusual meeting booked for February 2, described as "Building a Simple Receiver on the Spot—and we hope it Works!" So do we, and we shall be interested to hear more about it.

Reading, having held their AGM at the end of January, meet again on February 24 for a talk by G3OLA on "Useful Bits of Gear to have around the Shack"; this will be supported by working demonstrations.

Reigate have a Juniors' meeting on February 3; the 10th is the date for their Annual Dinner; and on the 17th they will be hearing about Unusual Radio Equipment, and the Army Emergency Reserve, from G3GVV.

Sutton Coldfield meet on February 8, when the subject is Test Instruments and their Construction; February 22 is booked for Club Station activities. **Yeovil** send in their first report for some years, and we gather than they still meet every Wednesday at the British Legion Headquarters. Recent events included a talk by G3OHM on Army Signals Procedure and one by G3OSH on pre-war Amateur Radio.

Acton, Brentford & Chiswick meet on February 20, when G3HBW will demonstrate and talk on his Transistorised Communication Receiver, which won the major prize at the Hobbies Exhibition; all will be welcomed, at the A.E.U. Club, 66 High Road, Chiswick, W.4.

Barnet heard a lecture from G8KW on the KW SSB equipment at their January meeting; on February 27 they will have a talk on Transistor Radio Components, and on March 27 G2UJ will lecture on Receivers. All meetings at the Red Lion, High Street, Barnet, 8 p.m.

Clifton will be holding a discussion on the coming season's outdoor events on February 23. Two transmitting field days, three D/F days and two D/F nights are planned.

Crawley recently held their AGM and elected G3TR chairman, G3FRV secretary and SWL J. A. Parsons treasurer; they now have a membership of 25. February 24 is booked for their Annual Dinner, and February 28 for G6CJ's lecture-demonstration on Aerials. Visitors from other Clubs will be welcome for both events. (And we can add that G6CJ on Aerials is particularly good value.)

Dursley have recently had a talk on the Heathkit SB-10U SSB adapter by G3HXN, and they also held a small Christmas party at the home of G3OXO,



A the anniversary dinner of the Hong-Kong Amateur Radio Transmitting Society in December, VS6EP was awarded the gold-plated president's key; this is a genuine, standard G.P.O.-type key, which really does work. The presentation was made by Mrs. Talbot-Jones, wife of the Wireless Engineer of the Hong-Kong G.P.O.

their treasurer. **Farnborough Technical College** are meeting regularly at the College, and local radio enthusiasts are very welcome. Courses of instruction, both R.A.E. and Morse, run on Monday and Wednesday evenings.

Exeter held their AGM in January and followed the business with a talk on chassis construction, aluminium soldering and receiver design. Normal meetings are held on the first Tuesday at the Y.M.C.A., St. David's Hill, Exeter, 7.30 p.m.

Manchester elected their officers for 1962 at the recent AGM; G3LGN is chairman, G3IOA secretary and G3LGC treasurer. The constructors' contest was judged by G6OM and G6NM, prizes going to G3PJK for a receiver, G3MYR for a Top Band mobile transmitter and G8OJ for a high-pass filter. The Club meets every Wednesday at the King George VI Club, North Road, Moston, at 7.30 p.m. February 7 and 21 are Practical Nights; February 14, Morse and R.A.E. Instruction; February 28, a talk on Radio for Beginners.

Northern Heights recently held their first Annual Dinner, attended by a large number of members and friends. On February 21 G6BX will describe his holiday in Interlaken, with slides; March 7 will be an informal meeting. Sportsman Inn, Ogden, 7.45 p.m.

North Notts held their Annual Dinner in Worksop, with an attendance of 41; and on January 25 the Nottingham A.R.C. paid them a visit; they are taking part in a hobbies exhibition organised by the Rotary Club of Worksop in April, and will exhibit a 150-watt station, a Top Band station, and possibly operational RTTY as well. G3PRD is a newly-licensed member, and two 14-year-olds have

NOTICE TO ALL HONORARY SECRETARIES

Appearance in this space is free to those Clubs who care to make use of it for publicity and the reporting of their activities. Hon. secretaries are asked to ensure that their reports, addressed "Club Secretary," Short Wave Magazine, 55 Victoria Street, London, S.W.1, reach us by the date given each month. It is impossible to write in late reports, received after we close for press. All reports must include the name and QTH of the hon. secretary, for publication in the address panel.

**Names and Addresses of Club Secretaries
reporting in this issue**

ABERDEEN: G. A. Roberts, GM3NOV, 111 Great Southern Road, Aberdeen.
 ACTON, BRENTFORD & CHISWICK: W. G. Dyer, G3GEH, 188 Gunnersbury Avenue, W.3.
 ARMS: N. A. S. Fitch, G3FPK, 79 Murchison Road, London, E.10.
 BARTG: Dr. A. C. Gee, G2UK, East Keal, Romany Road, Oulton Broad, Lowestoft.
 BARNET: E. W. Brett, G3LUY, 28 Edward House, Edward Grove, New Barnet.
 BRADFORD: M. Powell, G3NNO, 28 Gledhow Avenue, Roundhay, Leeds 8.
 BRITISH TIMKEN: J. B. Johnson, G3JJW, 44 Castle Avenue, Duston, Northampton.
 BURNHAM-ON-SEA: M. Lillington, 19 St. Mary's Road, Burnham-on-Sea, Somerset.
 BURTON-UPON-TRENT: J. Adkin, 25 Huntingdon Road, Stapenhill, Burton-upon-Trent.
 BURY: F. Stocks, G3IVG, 5 Waingate, Rawtenstall, Rossendale, Lancs.
 CLIFTON: E. Godsmark, G3IWL, 211 Manwood Road, London, S.E.4.
 CRAWLEY: R. G. V. Vaughan, G3FRV, 9 Hawkins Road, Tilgate, Crawley.
 CRYSTAL PALACE: G. M. C. Stone, G3FZL, 10 Liphook Crescent, London, S.E.23.
 DERBY: F. C. Ward, G2CVV, 5 Upland Avenue, Littleover, Derby.
 DURSLEY: T. G. Spencer, G3ILO, 1 Field Lane, The Quarry, Cam, Dursley.
 EAST KENT: D. Williams, G3MDO, Seletar, New House Lane, Canterbury.
 ENFIELD: V. Croucher, G3AFY, 15 Nelson Road, London, N.15.
 EXETER: S. Line, 46 Roseland Crescent, Heavilree, Exeter.
 FARNBOROUGH TECHNICAL COLLEGE: D. M. Manley, 8 Abbotswood, Guildford.
 GRIMSBY: P. Mason, G3NBN, 213 Clec Road, Clethorpes.
 GUILDFORD: J. R. Barker, G3PDX, 35 Banders Rise, Merrow, Guildford.
 HALIFAX: G. Sunter, 24 Booth Fold, Luddenden Foot, Halifax.
 HASTINGS: W. E. Thompson, G3MQT, 8 Coventry Road, St. Leonards-on-Sea.
 I.H.H.C.: M. Allenden, G3LTZ, 16 Grovefields Avenue, Frimley, Aldershot.
 LIVERPOOL: H. James, G3MCN, 448 East Prescott Road, Liverpool 14.
 MANCHESTER: A. B. Langfield, 2 Rowland Street, Moston, Manchester 10.
 MIDLAND: C. J. Haycock, G3JDJ, 360 Portland Road, Birmingham 17.
 MITCHAM: M. Pharaoh, G3LCH, 1 Madeira Road, Mitcham.
 NORTHERN HEIGHTS: A. Robinson, G3MDW, Candy Cabin, Ogden, Halifax.
 NORTH KENT: B. J. Reynolds, G3ONR, 49 Station Road, Crayford.
 NORTH NOTTS.: E. N. Badger, G3OZN, 20 Tennyson Drive, Worksop.
 PADDINGTON: N. A. Lambert, G3LVK, 2 Warwick Crescent, Paddington, W.2.
 PETERBOROUGH: D. Byrne, G3KPO, Jersey House, Eye, Peterborough.
 PLYMOUTH: R. Hooper, 2 Chestnut Road, Peverell, Plymouth.
 PURLEY: E. R. Honeywood, G3GKF, 105 Whytecliffe Road, Purley.
 RAIBC: W. E. Harris, G3DPH, 4 Gianville Place, Kesgrave, Ipswich.
 READING: R. G. Nash, G3EJA, 9 Holybrook Road, Reading.
 REIGATE: F. D. Thom, G3NKT, 12 Willow Road, Redhill.
 SOUTH BIRMINGHAM: T. W. Legg, Flat 3, 80 Alcester Road, Birmingham 13.
 SOUTHGATE: R. W. Howe, G3PLB, 162 Victoria Road, London, N.22.
 SOUTH HANTS: G. J. Meikle, G3NIM, 34 Victoria Road, Netley Abbey.
 SUTTON COLDFIELD: L. E. R. Hall, G3IGI, 24 Calthorpe Road, Walsall.
 THAMES VALLEY: K. A. H. Rogers, G3AIU, 21 Links Road, Epsom.
 WEST KENT: *Hon. Secretary's name/QTH not given.*
 WOLVERHAMPTON: J. Rickwood, 738 Stafford Road, Fordhouses, Wolverhampton.
 YEOVIL: D. L. McLean, G3NOF, 9 Cedar Grove, Yeovil.

both passed R.A.E. and are nearing the Morse test.

An attempt is being made to re-establish the **QAU Club** (Jersey, C.I.), premises being sought at present, and it is hoped to get going during the next six months. They envisage a workshop and a station (GC3DVC) and the target is to keep the premises open to members for 24 hours a day; anyone in Jersey who is interested is asked to contact GC2CNC.

Southgate meet on February 8 for a talk on Selenium Rectifiers (STC) and on March 8 for one on Interference (Belling-Lee). Both meetings at Arnos School, Wilmer Way, N.14.

The **Southampton** Group meet at Southampton University on February 10 at 7 p.m., when it is hoped to organise a talk on SSB. February 17 is booked for the Annual Dinner and Social, at the Cotswold Hotel, 7.30 p.m. Visitors welcome, and tickets (21s.) from G3MDH. Next regular meeting will be on March 10, when a talk will be given by G3FZL.

Thames Valley held their AGM "mid ice and snow," but had a good attendance nevertheless. A successful year was reported, particularly in the junior section, and a promising programme for the New Year is presented, with some first-class lectures and outdoor events. All members serving overseas will be elected honorary members in future, on an annual basis.

Wolverhampton have a talk, on February 12, on the building of the G2DAF receiver; this will be given by G3UK. On the 26th G3HAZ will talk on VHF and UHF aerials. Both meetings 8 p.m. at the headquarters, Neachells Cottage, Stockwell End, Tettenhall.

Bury report once more (note new secretary's QTH, in panel) to say that they meet on the second Tuesday at the Knowsley Hotel, Kay Gardens, Bury, 8 p.m. On February 13 G2HW will give his annual lecture (subject not yet known).

Guildford notify us of a Junk Sale on March 8, and their AGM on April 12; they are also running a Car Rally (date to be fixed). G3HTP and G3OXI are still working on the Club's two-metre receiver.

Liverpool hold their annual Hamfest on February 3 at the Stork Hotel, and tickets (price £1) are obtainable from the secretary; all amateurs and

CLUB PUBLICATIONS RECEIVED

We acknowledge, with thanks, receipt of the following Club Publications: **A.R.M.S.** (*Mobile News*, November); **B.A.R.T.G.** (*News Sheet*, No. 15); **Crystal Palace** (*Newsletter*, No. 73); **Derby** (*Newsletter*, No. 6); **East Kent** (*The Carrier*, December); **Enfield** (*Lea Valley Reflector*, December); **Grimsbey** (*News Sheet*, December); **Guildford** (*Monthly Natter*, No. 14); **Hastings** (*Natter-Net Notes*, December); **I.H.H.C.** (*Newsletter*, November); **Midland** (*News Letter*, November and December); **Mitcham** (*Newsletter*, December and January); **North Kent** (*Newsletter*, Nos. 51 and 52); **Purley** (*News Sheet*, December); **R.A.I.B.C.** (*Radial*, December and January); **Reigate** (*Feedback*, No. 21); **South Birmingham** (*QSP*, November and December); **Southgate** (*Newsletter*, December and January); **South Hants** (*QUA*, December); **Wolverhampton** (*Newsletter*, December and January); **West Kent** (*QLF*, January); and **R.S.E.A.** (*QTC*, December).

SWL's in the district welcome. One of the attractions is to be a colour film of Club activities, by G3HII.

On February 9, G2UJ is to talk to **West Kent** about "Oscar," with which he has been prominently connected; on February 23 they have an Audio Night, and on the 28th *West Kent* visit *Crawley* for G6CJ's Aerial Lecture. Their programme has been fixed up to May 11, meetings are held at Culverden House, Culverden Park Road, Tunbridge Wells, and visitors are welcomed.

Paddington met for their first AGM on January 10, when satisfactory progress was reported, including participation in the local Venice Festival and in MCC, also the founding of their own monthly *Keyklix*. Officers elected include G3JEA chairman, G3LVK hon. secretary, G3KNL treasurer, and G3MHQ and G8PL as committee members. The president is Mr. D. S. Jewiss, and the winners of the "Beauchamp Lodge Award" for the year were SWL's L. Hogan and R. Wood.

ULTRA "TIDEWAY" R/T APPARATUS FOR YACHTSMEN

At this year's Boat Show, Ultra Electronics, Ltd., showed their new "Tideway" marine equipments. These are compact, precision built units, designed for use in small yachts and launches. They are ideally suited to vessels requiring a "voluntarily fitted" R/T installation for ship-to-shore and ship-to-ship communication. A tunable band is also provided for

broadcast listening. Transistors in all but the transmitter output stage ensure a very high standard of reliability and a receiver battery drain of only 6 watts. Operation is within the 1.6-4.0 mc band; each channel frequency is crystal controlled to well within the international limits. A "press-to-talk" hand microphone controls the change-over from "transmit" to "receive."

The Ultra Model TR4A0 is an RT and CW transmitter/receiver of 28 watts RF output. A front panel switch selects any one of up to five transmit and receive channels within the 1.6-4.0 mc band. This arrangement permits pairing of a number of possible transmit and receive channels, a feature which is particularly useful in local waters. A three-band tunable receiver covers the long and medium broadcast bands and marine communications band. The receiver sensitivity is 2 microvolts for 3 watts audio output. Total battery consumption (12v.) is: Receive, 0.5 amp; Standby, 1.5 amp. Transmit, 8 amp. Dimensions are 14in. high, 12½in. wide and 12in. deep.

The Ultra Model TR3A8 is a transceiver of 50 watts RF output and 3 watts audio output. Any one of up to eight channels in the range 1.6-4.0 mc can be selected. A broadcast band, tunable within the range 550-1600 kc, is also provided. Battery consumption (12v.) is: Receive, 0.5 amp; Standby, 2.5 amp; Transmit, 17.5 amp. Dimensions of this unit are 7½in. high, 14in. wide and 11¼in. deep. With a crystal or two for Top Band, the TR4A0 might make a very useful /M installation on a 12v. supply.

SSB - AM - CW

NEW & FULLY RECONDITIONED TRANSMITTERS & RECEIVERS

Cost includes insurance & freight to you

Transmitters — Power Output: Reconditioned

CENTRAL ELECTRONICS :

20A/458 VFO — 160-15M; 20W, SSB, CW — 7W, AM \$199
20A/458 VFO — 160-10M; 20W, SSB, CW — 7W, AM \$220

E. F. JOHNSON :

Invader — 80-10M; 100W, SSB, CW — 25W, AM ... \$590

HAMMARLUND :

HX 500 — 80-10M; 100W, SSB, CW — 25W, AM ... \$647

HALLICRAFTERS :

HT 37 — 80-10M; 70-100W, SSB, CW — 17-25W, AM \$395
HT 32B — 80-10M; 100W, SSB, CW — 25W, AM ... \$715

Receivers: Reconditioned

HALLICRAFTERS :

SX 101A — 80-10M \$435
SX 111 — 80-10M \$279
SX 115 — 80-10M \$560

HAMMARLUND :

HQ 170 — 160-6M \$353

DRAKE :

2B — 80-10M ... \$277

WORLD WIDE

WRITE W9ADN

ORGANS & ELECTRONICS

P.O. Box 117, Lockport, Illinois, U.S.A.

QUARTZ CRYSTAL UNITS

Hermetically sealed, Gold Electroded Crystals in the Frequency range 3 Mc/s to 15 Mc/s at £1. 1. 0 each and 20 to 30 Mc/s at £1. 10. 0 each post free. State holder type preferred—HC-6/U or FT243.

PROFESSIONALLY MADE FOR THE AMATEUR

Send cash with order stating exact frequency and you will receive an Oscillator Circuit Diagram with your crystal.

Booklet "Guide to Specification and Use of Quartz Oscillator Crystals" 5/-.

CATHODEON CRYSTALS LTD. Linton, Cambridge

YOU TOO CAN GO ON TWO!

WITH THE TW RANGE OF V.H.F. EQUIPMENT
"Top of the hill performance at a down to earth price"

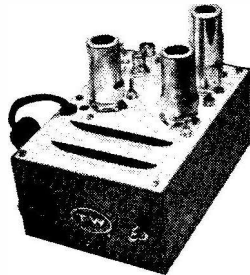

TW NUVISTOR CONVERTER

Built-in P.S.U.
Silver Plated Chassis
Excellent Noise Factor
£15

ALSO AVAILABLE:—

- TW Cascode Converter (You state I.F.) ... 11 gns.
- TW Converter P.S.U. (Silicon Rectifier) ... 4 gns.
- TW Nuvistor Pre-amplifier with built-in P.S.U. ... 6 gns.
- TW Mains Supply/Control Unit (Matches the TW2) ... 13 gns.
- TW Transistor Supply/Control Unit (12v.) ... 21 gns.
- TW Halo Antenna (Easily mounted) ... £2.17.6
- TW Mobile Mike (Crystal insert) ... £2.19.6
- TW 2 Metre V.F.O. (Complete with Buffer Amplifier C.W. or N.B.F.M. at the flick of a switch) ... £28. 0. 0

For full details of this equipment write to:—

T. WITHERS (Electronics)

15b GILBERT STREET, ENFIELD, MIDD.
G3HG Tel. Waltham Cross 26638 G3HG

G4GZ's BARGAINS

VALVES: EA50, EF50, 1/6. 6H6M, EB34, 6K7G, 2/-, 2X2, 6B8G, 12SC7M, EF36, EF50(S), 2/6. 6AL5, 6AM6, ARP12, AR8, EAC91, EB91, EF91, EL32, TT11, VP23, Z77, 3/-, 1L4, 6C4, 6J6, EF39, 3/6. 6AC7M, 6SN7GT, 1626, 1629, DC70, DF73, DL70, 4/-, 6AK5, 6J7G, 6ST7M, 12A6M, 12K7G, 12Q7G, 12SJ7M, 35Z4G, 959, EBC33, 5/-, 3Q4, 6BH6, 6B16, 6F6M, 6K8G, 6SJ7M, 6SL7GT, 6X4, 5/6. 1S5, 1R5, 6AU6, 6BA6, 6/-, 12AU7, 12AT7, 80, KT33C, ECC81, ECC82, PY80, 6/6. 12AT6, 6L6G, 6V6G, 12AU6, 12BE6, 12CBM, 42, GTIC, PCF82, PY83, VR150/30, 7/6. 2A3, 6AQ5, 6BW6, 6L7M, 12SQ7M, ECC84, EBF80, 8/6. 3A5, 6K8M, 6L6M, PCC85, 9/-, 50L6GT, EM80, 5R4GY, 6Q7GT, EL84, 9/6. 12K8M, DET24, EABC80, EC80, GZ32, VLS631, 10/-, 5763, 446A, ECL80, ECH42, 10/6. 805, 3E29 (829B) 25/-, 4E27 (HK257B) 40/-.

Post/packing 6d. per valve. Free over £3.

SPECIAL OFFER for VHF men. EC80 (GGT 12 m/a pv.) original cartons, 3 for 20/- (P/P 1/6); 446A, 3 for 20/- (P/P 1/6).

AR88 Ceramic tube trimmers, 4 for 6/-. Smoothing chokes (10H 100 m/a), 3 for 21/-.

POTTED U.S.A. XFMRs. 230v. input; 32, 34, 36v. 2A O/P., 17/6.

MC METERS: 3 1/2" rd.fl. (2 1/2" dial) 0-500 m/a, 0-30 m/a, 0-15v. AC (Mil. cal. at 50cps), 16/6. 2 1/2" rd.fl. (2" dial) 0-1 m/a, 22/6. 2" rd.fl. 0-500 μ A, 17/6. 0-30 m/a (5 m/a basic), 10/6. 2 1/2" rd. plug-in, 0-1500v. electrostatic, 19/6. 0-250 μ A, 22/6.

ET4336 TRANS. 190-250v. input. 10v., 10A, CT, 2 1/2v. 10A CT twice, 35/-, B9A moulded v/hdrs. with screens, 11/6 doz. Micalox ditto, 13/6 doz. Pyranol 10mfd. 2Kv. oil-filled, 27/6.

25 PFD AIR SPACED CER. TRIMMERS, 3 for 5/-, 17/- doz.

BSR MONARDECKS. New boxed, £7/10/-.

All above except valves carr. paid U.K. mainland. SAE enquiries. also

EDDYSTONE RECEIVERS — FERROGRAPH TAPE RECORDERS — LEAK — QUAD — GARRARD — WHARFEDALE — GOODMANS, ETC. HI-FI EQUIPMENT. FINEST SELECTION IN THE COUNTY.

JOHN ANGLIN

385, CLEETHORPE ROAD, GRIMSBY, LINCS. Tel. 56315

SMALL ADVERTISEMENTS

("SITUATIONS" AND "TRADE")

9d. per word, minimum charge 12/-. No series discount: all charges payable with order. Insertions of radio interest only accepted. Add 25% for Bold Face (Heavy Type). No responsibility accepted for errors. Replies to Box Numbers should be addressed to The Short Wave Magazine, 55 Victoria Street, S.W.1.

SITUATIONS VACANT

AIR MINISTRY have vacancies for CIVILIAN RADIO TECHNICIANS at R.A.F. Sealand, Cheshire; R.A.F. Carlisle; and other R.A.F. stations throughout the United Kingdom for the servicing, repair, modification and testing of air and ground radio and radar equipment. Commencing salary (National) (according to age) is £630 to £810 p.a.; max. salary £930 p.a. Rates are subject to small deduction at certain provincial stations. A limited number of houses may be available for renting at West Kirby, some 15 miles from Sealand.—Apply to Air Ministry, C.E.3h, Princes House, Kingsway, London, W.C.2, or to any Employment Exchange, quoting City O/N 2427.

TRADE

GO ONE BETTER. Have your cabinets, panels, etc., stove-enamelled and lettered to your own or original specification.—For by-return quotations, contact: The Universal Productions (Enamellers) Ltd., 22 Aston Road North, Birmingham, 6. (Tel. Aston Cross 2987.)

WANTED FOR CASH: Good clean communication receivers and SSB equipment. Please state price.—Short Wave (Hull) Radio, 30/32 Princes Avenue, Hull. (Tel. 18953.)

QSL's and Logs by Minerva. The best there are.—Q Samples from Minerva Press, 2 New Road, Brentwood, Essex.

QSL CARDS AND LOG BOOKS, G.P.O. APPROVED. CHEAPEST, BEST. PROMPT DELIVERY. SAMPLES.—ATKINSON BROS., PRINTERS, LOOE, CORNWALL.

WEBB'S LOG BOOK for recording signals heard and worked; 112 pages 9 1/4 in. x 8 in., approved format, semi-stiff covers. Excellent value; 6s. 1d. post free, or callers 5s. 4d.—Webb's Radio, 14 Soho Street, London, W.1.

QSL CARDS: Buff, blue, pink, green. 100, 14s. 6d.; 250, 23s.; 500, 40s.; 1,000, 75s.—Samples (s.a.e.): Reilly, Panxworth, Norwich, 56.Z.

READERS' ADVERTISEMENTS

3d. per word, min. charge 5/-, payable with order. Please write clearly, using full punctuation and recognised abbreviations. No responsibility accepted for transcription errors. Box Numbers 1/6 extra. Replies to Box Numbers should be addressed to The Short Wave Magazine, 55 Victoria Street, S.W.1.

R. 107, in really excellent condition, with phones. S-meter and manual. Above-average price of £12 (no offers) asked for this far-above-average specimen; will deliver.—Ford, Burgh-Heath (Surrey) 3578.

SMALL ADVERTISEMENTS, READERS—continued

URGENTLY REQUIRED: The official manual for the TCS-12; good condition important.—Particulars to: Brain, 75 Elmbridge Road, Perry Barr, Birmingham, 22B.

K. W. VICTOR, as new, £65. Minimitter amateur-band converter, £13. Mosley TA33 3-band beam, £15, or offers? Delivery 65 miles.—G3MEW, 5 Testcombe Road, Gosport, Hants.

MANUAL for HRO Model 5T, Army-type R.106, Mk. II, urgently required. — G3DVH, 35 Benning Avenue, Dunstable, Beds.

FOR SALE: Vanguard, AR88, 28 mc Bi-square, rotator, wavemeter, TF643A Z-Match; buyer inspects and collects; £70 the lot.—G3MEA, The Bungalow, Whickham Highway, Dunston, Gateshead 11, Co. Durham.

TR 1985 (100/125 mc), complete, but needs attention, £7. SWL requires Teleprinter (swop for TR1985 or cash). — D. Gray, Sunderland Road, Easington, Co. Durham.

EDDYSTONE 840A, mint order, internal/external speakers, less than year old, £30 plus carriage.—Faulkner, Grange Hostel, Farnborough, Hants.

WANTED: R.107 Receiver, preferably unmodified. Please state your price.—S. Alexander, 88 Cheyne Walk, Grange Park, London, N.21.

WANTED: 811's or 811A's. State quantity and price. **SALE:** Two Transceivers, No. 88, with valves and crystals, £1 5s. each.—GM3BQA, 19 Edinburgh Road, Cockenzie, East Lothian.

CR-100, fair condition, £8; Calibrator No. 10, new, 3v. heaters, 50s.; 19 Set, 2-8 mc Rx only, £1. Pye 13-channel TV, perfect, £5. 3w. amplifier, 30s.; 39/1 mike, £1. Other items.—Enquire (s.a.e.) Chaplin, 76 Hillside Avenue, Bitterne Park, Southampton, Hampshire.

WANTED: R.1155, L or N; or BC-348, unmodified and in good condition. — Write, stating price, to: Bonnett, Shawes Drive, Anderton, Chorley, Lancs.

WANTED: Minibeam or similar. — Price and particulars: G3NQU, 82 Oakengrange Drive, Southend-on-Sea, Essex.

B. S.A. Bantam, 125 cc., Oct. 1952; battery lighting, new tyres, good condition; offered in exchange for good BC-221 wavemeter.—Box No. 2562, Short Wave Magazine, Ltd., 55 Victoria Street, London, S.W.1.

WANTED: Good amateur transmitter.—Box No. 2563, Short Wave Magazine, Ltd., 55 Victoria Street, London, S.W.1.

K. W. VANGUARD, 160-10m., immaculate, spare K valves, two mikes, £45. No offers (buyer collects).—GW3LSB, Coed Derw Bach, Betws-y-Coed, Caerns. (After 5 p.m. or week-end.)

SALE: Vibroplex Bug, £5. HRO GC coil, 7-14 mc, £1.—Stancey, 61 Astley Lane, Swillington, Nr. Leeds.

GOING SIDEBAND: AR88D, £38 10s. DX-100U, little used, £55. — Phone ARN. 8470, 34 The Farway, Wembley, Middx.

Minimitter

High performance Equipment

The 'F.B.5.' All-Band Aerial
Ferrite Bead Loaded
Five Bands
For 'F.B.' Signals
Price £5. 0. 0 complete
Double Bay Stack Array £9. 10. 0

The World Renowned 'Minibeam 10/15'	£16
The latest 'X20' Rotary Beam ...	£10
Adaptation Kit to allow mounting on Minibeam 10/15 ...	£2
The Minimitter Telescopic Mast, 34 ft. Complete with all fittings ...	£10

The MR44/11 Communications Receiver. Outstanding performance ...	£65
The SB7M S.S.B. Transmitter. 140 watts. S.S.B.—C.W.—A.M.—P.M. ...	£130
The 'Top 2-7' Compact Transmitter. 24 watts, self-contained ...	£28.10.0
The 'MERCURY 200' High Power All Band Transmitter ...	£110
The Famous Minimitter Converters:—	
The 'Amateur Band' (5 Band) self-contained ...	£17
The 'MC8' (8 Band) with general coverage ...	£20

For details of any of the above, please send S.A.E. to:—

THE MINIMITTER CO. LTD.

37 Dollis Hill Avenue, London, N.W.2. Tel. MAIda Vale 5588

THE SPOT THE SPOT

G3EKX

DERBY Tel. 41361

THE TOP TEN

- EDDYSTONE RECEIVERS.** 870A, £33 18s. and the new 840C, £58.
- HALICRAFTERS.** HT37, £215; SX101A, £187; SX111, £120; SX110, £78; 538E, £28 10s.
- BIRKETT'S BETTER BEAMS.** 8 element Yagi. Wide spaced for 2 metres, 59/- with 1" to 2 1/2" adjustable bracket, 5 element, 39/6. Add on 3 element for fitting to 5 element, 19/6. All plus 3/6 carriage.
- NYLON ROPE** for Guys, etc., 1/2" circumference, 3d. per ft. 3/4" circ., 4d. ft., 3/4" circ., 6d. ft., 1/2" circ., 8d. ft. Tremendously strong. Add P.P.
- VIBRATOR, 12v. SUPPLIES.** As used with PCR3 Radio. 300-350 volts O/P 120 m/a's. Mint condition with spare vibrator and leads, in original packing, unopened, 25/- each, 7/6 carr. Don't miss this real bargain offer.
- AERIAL MAST KITS.** NB48', £15; NB36', 12 gns.; NB24', 7 gns. Alloy tubing, 1", 1/6; 3/4", 1/1; 1/2", 11d.; 3/8", 8d.; 1/4", 6d. per foot. 14 feet x 2" O/D Dural Masts, 63/9 each; 16 feet x 2" O/D, 75/-. All plus carriage.
- FORCES RADIOS. BRAND NEW BOXED.** In excellent condition. 200-550 metres. 6K8, 6K7, 6Q7, 6V6, superhet. Large dial. 8" p.m. speaker. All in cabinet with 6 volt sync. vib. unit. Leads circuit diagram. Conversion to 160m., 80m. and mains would be easy. 69/6 each, Carr. 9/-.
 8 **STABILISED POWER UNITS.** 11P—115v. or 230v. A.C. 80 c.p.s. O/P—350v.—125 m/a. and 180-220v. stabilised. Also neg. bias O/P 120v. stabilised and 6.3v. 12 amps. (plus). This pack is extremely well made with five valves, double chokes, paper condensers, etc. All tested on mains 230v. before despatch. Size: 16 1/2" x 8 1/2" P.P. Price, real snip, 95/- each, carriage 10/-.
 9 **S.B. BITS AND PIECES.** OA79 pairs, 6/- P.P. 6d. M.S.E. 1.F.s. 12/6 pair, P.P. 6d. 3" square, long and short types, cans, formers and slugs, 1/6 each, P.P. 6d. Ferrite 1" rings, 3/6 each, P.P. 6d. 898 Eddystone Dials, 71/4, 2/6 P.P. 1k. lin. carbon, 5/- each, P.P. 9d., etc., etc.
- JAP STICK MIKE.** Black and chrome (xtal) beautifully designed with switch, neck cord, screw fitting for base. 100-8,000 c.p.s., 39/6 + 2/- P.P. Heavy base to match 12/6 + 1/6 P.P.

Most goods as advertised in recent issues of Short Wave Magazine still available, BY RETURN SERVICE, SUBJECT TO POSTAL DELAYS.

NORMAN BIRKETT LTD
THE SPOT, 26 OSMASTON ROAD, DERBY

YOUR HOBBY IS OUR HOBBY

AT ORGANFORD the commercial side takes second place. We carry on our work because we love our hobby and because we value so much the friendships that arise from it. OUR AIM is to be of help. We want to assist those whose circumstances prevent them having easy access to the goods we sell and it is our constant desire to help them find the items that interest them. Items that will provide hours of happy relaxation in pursuit of their hobby. A HOBBY UNIQUE in that it can provide countless items of commercial manufacture in new condition that cost pounds to produce for as many shillings or even less. Every year we sell to enthusiasts many unusual items and in this way the hobby they love is perpetuated, and their pleasure forms the foundations on which younger generations can build.

THAT THIS HOBBY of ours forms a bond between different nations is clearly visualised — there is not a country in the world where a Radio Ham cannot be sure of finding a friend, and through this hobby of ours which knows no international barriers we play our own small part in promoting goodwill.

Our Lists of forty foolscap pages containing details of over 1,000 different items in stock are available. Many of these items are unobtainable elsewhere.

P. HARRIS, Organford, Dorset

SHORT WAVE (HULL) RADIO

G5GX

	£	s.	d.
HRO's with coils and P.S.U. from	25	0	0
EDDYSTONE 840A. 550 kc/s. to 30 mc/s.	37	10	0
EDDYSTONE 770R. 19 to 165 mc/s.	185	0	0
EDDYSTONE 840C. 550 to 30 mc/s.	58	0	0
MINIMITTER MR44. Immaculate. Amateur bands only	39	0	0
MINIMITTER MR44/2. Immaculate. Amateur bands only	49	0	0
NATIONAL NC60. 550 kc/s. to 30 mc/s. bandspread B.F.O., etc.	25	0	0
NATIONAL HRO "SIXTY." 1.7 to 30 mc/s. Immaculate	185	0	0
HALLICRAFTERS SXIII. 80, 40, 20, 15 and 10	128	0	0
HALLICRAFTERS SX140. 80, 40, 20, 15, 10 and 6	56	10	0
HALLICRAFTERS SX101A. 80, 40, 20, 15 and 10	187	0	0
L.G. 300. RF section only	35	0	0
BIRDCAGE AERIAL. 20 and 15	12	0	0
LABGEAR 28 mc. BISQUARE	7	0	0
THE R.S.G.B. AMATEUR RADIO HANDBOOK	1	14	0

Carriage extra on all the above items

30-32 PRINCES AVENUE, HULL

Telephone 18953

SMALL ADVERTISEMENTS, READERS—*continued*

WANTED: Morse Record, also HRO manual and set of coils.—W. J. Pope, 23 Herbert Road, Rainham, Gillingham, Kent.

MOBILE RIG Rx R.209, 10-valve, 1-20 mc. 12v. DC home-brew, 160m. Tx, high-level mod., rotary P/S. £28. **WANTED:** Communications Rx, Heathkit GDO, and Valve Voltmeter, etc.—G3MAD, 70 Arnold Road, Binstead, I.o.W. (Ryde 3231.)

888A EDDYSTONE Receiver with matching speaker and S-meter, as new in original packing case. For quick sale, £68 (including carriage).—First cheque with s.a.e. to: Potter, 4 Trevelyan Road, Seaton, Devon.

MOBILE Tx, Minimitter, 160-80-40 metres, AM and CW, £11 10s. KW Transistor PSU, 12v. input, 300v. 130 mA output, £8 10s. Eddystone 840A receiver, £25. 19 Set power supply (converted to positive chassis for mobile use), 25s.—Only after 8 p.m.: G3NXU, 18 Broadlands Avenue, Keynsham, Bristol.

TIGER T150, less modulator, 10/15/20m. in 3-tier rack (32 ins. x 20 ins. x 12 ins.); cost £100; accept £30. WAS and DXCC worked with this Tx. New valves, Osram DA41. Offers? Stamp, reply—G2UZ, 2 Cliff Road Gardens, Leeds, 6.

BC-342N, handbook and transformer, good condition; prefer buyer collect, inspect; £12 o.n.o.—G3NXY, 160 Manor Farm Road, Bitterne Park, Southampton.

THE GREENFORD AMATEUR RADIO SOCIETY offers a 36 Tx, complete, for £6.—Enquiries, please, to hon. sec., E. C. Gray, G3CPS, 111 Ravenor Park Road, Greenford, Middx.

AR77: Bargain, £7; maker's handbook, spare valves, RF amp./section Yaxley, wafer worn (wants changing); view and collect.—G3JFB, 267 Kingston Road, Ewell, Surrey. (EWE, 7577 after 7 p.m.)

KW GELOSO Converter, self-contained power supply, stabilised, 10-80 metres bandspread, 4.6 mc IF output, £12 15s. post paid.—Edwards, 244 Ballards Lane, N.12. (Hillside 4321.)

FOR SALE: R.88 (1475) and PSU, £10. T.1154 power units, HT and LT, 1 cwt. each, £8. 36 Sender, complete with modulator, etc., £10. VHF Rx, less PU, £3. Bush Rx, 6 bands, 550 kc-30 mc, £5; manuals, other gear; buyer collects.—J. V. Firth, 10 Ridgway Avenue, Darfield, Nr. Barnsley, Yorkshire.

FIRST-CLASS VHF Receiver, Type R.1392, unmodified and complete with 15 valves, S-meter, etc.; covers 95 to 150 mc; £3 10s. (carriage paid).—Beadle, 6 Chapel Cottages, Thearne, Beverley, Yorks.

WANTED: High-grade Communications Receiver 75A4, Hammarlund SP600-JX, Collins R.390A or R.391, etc. Also cheaper type as stand-by set. Cash waiting.—Clappison, 291 Beverley Road, Hull.

A MATEUR, selling out: AR77, Tx's, BC-221, AVO-7, R/C Bridge, chokes, transformers, valves and components.—Enquiries: G3DZ (KINGston 9865.)

SMALL ADVERTISEMENTS, READERS—continued

FOR SALE: AR88D Receiver, fitted S-meter, complete with manual. £37 10s.—Stanley, 44 The Lindens, Harborne, Birmingham. (Phone: Bearwood 3178.)

JOHNSON VIKING INVADER. mint condition. 200 watts SSB/CW. 90 watts AM. with auto-transformer, £250.—G5RP, Old Gaol House, Abingdon, Berks. (Telephone 380.)

FOR SALE: RCA Speech Amplifier, Ex 4336 Tx, all valves, as new, manual, available for loan, bargain, £5, carriage 7s. 6d. 3/RCA-805 at 22s. each; 2/813, 22s. each; 4/866A at 10s. 6d. each; all new and unused (postage extra).—G5FH, 17 Knottshall Lane, Oldbury, B'ham.

WANTED: Eddystone or Hallicrafters Receiver, good condition. R.1155 would be suitable if not modified.—Box No. 2564, Short Wave Magazine, Ltd., 55 Victoria Street, London, S.W.1.

TOP BAND Command Rx, £9; 12v. Dynamotor, 35s.; TCS-13 Rx, £8; mains p/pack for same, £3; TCS Tx loading coil, 30s.; HRO p/pack, £3; SX24 manual, 21s.; all mint condition and plus carriage. **WANTED:** W./E. VHF Converter AM/TRC-913; 2-metre Tx's; T.1540; R.E.E. T.40, or similar commercial VHF unit. Receivers GPR-90, CR-91, SX-28A, SX-71, S.640; Command Rx, 28-41 mc. All must be in first-class condition.—Details and price to: C. Hodgkinson, 19 Stoney Lane, Galgate, Lancaster.

CR-100 RECEIVER, noise limiter, good condition, spare valves, £17 o.n.o.?—Shaw, 9 Daver Court, Mount Avenue, Ealing, London, W.5.

LG. 300, 1250v. power supply, spare new 813, UM3 mod. xfr., £25 collected.—Dickenson, 46 Lichfield Drive, Warden Hill, Cheltenham.

A MATEUR, just returned from abroad, would like to buy gear, especially AR88D, TV1-proofed SSB/AM Rig, AVO or similar meter.—Reply, with full details and lowest price, to: H. P. Henry, 19 High Ash Avenue, Alwoodley, Leeds, 17.

HRO-5T purchased new, stored, few hours' use, unmodified, unmarked, original pristine condition; six coils, p/pack, manual; best offer? 120w. CW all-band Tx, £10.—Box No. 2565, Short Wave Magazine, Ltd., 55 Victoria Street, London, S.W.1.

GELOSO VFO/807 Rig. Phone/CW. 25w. table-top, £12 10s. Exchange for BC-221, other gear.—Eley, 162 Franklin Road, Birmingham, 30.

FOR SALE: 12 Set, as new, built-in PSU, £16 o.n.o.? **WANTED:** GeloSO G209R in mint condition.—Baker, Goodrest, Sydenham Road South, Cheltenham, Glos.

SALE: DX-40U and VFO, manuals, £25; Hammarlund SP400SX, PSU, handbook, £36; delivered 50 miles. **WANTED:** Mohican.—G3OLA, 34 Woosell Lane, Wokingham, Berks.

NEW Minimitter MR44/11 Receiver with speaker, £50.—Apply Pugh, 51 Kirkstone Road, North Litherland, Liverpool, 21.

HOME RADIO OF MITCHAM FOR YOUR NEW EDDYSTONE "840C"

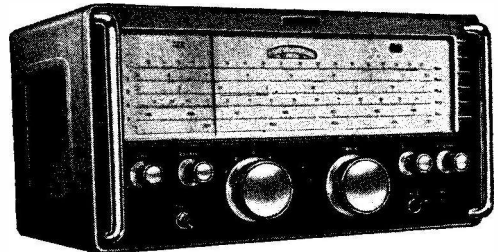

£58 Carriage paid U.K.
(Overseas shipping arranged)

GRAMPIAN DP4 MICROPHONE

Slender elegant high quality moving coil microphone suitable for hand or desk use. Response 50 to 15,000 cycles and available in low, medium, or high impedance. High impedance model with adaptor and base as illustrated. **PRICE** £9. 19. 6 post paid



KW ELECTRONICS TRANSMITTERS, HEATHKITS,
and MOSLEY AERIALS STOCKED.

Dept. S. 187 London Road, Mitcham, Surrey. MIT 3282
Shop hours 9-6.30 p.m. (Weds. 1 p.m.)

G. W. M. RADIO LTD

RECEIVERS CR100 Marconi. Air tested before despatch, £17/10/-, carriage £1.

COSSOR 339 Oscilloscopes, good working order, £12, carriage £1.

BAROMETERS, approximately 6" diameter, Brass case, wall mounting, calibrated in Millibars, 35/-, post 5/-.

AUDIO OSCILLATORS B.S.R. type LO50, £10, carriage 15/-

RESISTORS. 100k $\frac{1}{2}$ watt box of 6, 6d.; 1 meg $\frac{1}{2}$ watt box of 6, 6d.; 10k $\frac{1}{2}$ watt box of 3, 3d. Postage under 12, 1/- — over free.

RECEIVERS R1132, good condition, £4, carriage 10/-.

FIELD TELEPHONES, type D Mk. V, new and boxed, 39/6, post 3/6.

TIME SWITCHES. 14 day, 5 amp contacts as removed from street lamps, good working order, complete with new key, 15/-, post 2/6. These have "Quick Make-Break" contacts and are suitable for D.C. or A.C. up to 250 volts.

POWER UNITS, 19" rack-mounting type 3, 230 A.C. input, 250 D.C. 100 M/a. and 6.3 A.C.5 amp. out, 39/6, carriage 10/-.

AMPLIFIER, type N24, 230 A.C., 4 watts output at 600 ohms, output transformer easily changed, 35/-, carriage 10/-.

CLOCKS. Ex-Navy, wall mounting, good quality 8-day movement, overhauled, guaranteed 12 months. Black case, £4/10/-, Brass, £5/10/-, post 5/-.

LOUDSPEAKERS, 10" in wood box, 3 ohm with 600 ohm line transformer, 12/6, carriage 5/-.

52 RECEIVERS. We regret these are all sold. We still have components as previous adverts, including 813 valves at £1, post 2/6 tested. Base 2/6, post 9d.

3" PYREX RIBBED AERIAL INSULATORS, 1/6, post 1/- up to 6, over free.

All equipment offered is complete but not tested unless otherwise stated. Carriage charges are for Mainland only.

Terms: Cash with order. Early closing Wednesday.

40-42 PORTLAND RD., WORTHING, SUSSEX

SMALL ADVERTISEMENTS, READERS—*continued*

HRO SENIOR, good condition, power pack, 6 coils. L/Speaker, manual, £20; buyer arranges own collection.—Box No. 2566, Short Wave Magazine, Ltd., 55 Victoria Street, London, S.W.1.

WANTED urgently: BC-453.—A. Garrett, 18 King Street, Duffield, Nr. Derby.

WANTED by ZL1AH: HRO Senior GC coils 0.55-4 mc; also Woden UM3. All letters answered.—Wightman, Welcome Bay, Tauranga, New Zealand.

WANTED: Self-contained Commercial AM/CW Tx in good condx., preferably all-band; up to £45 offered. Also ATU.—Simpson, 5 Berryfields, Melksham, Wilts.

PANDA EXPLORER, 150-watt, 15-valve, band-switched table-top Tx, pair 6146 in final, working instructions and circuit diagram, new condition, £38; buyer collects or pays carriage.—G6RF, Talltrees, Lower Cookham Road, Maidenhead (Tel.: 3594), Berks.

FOR SALE: HRO fitted with Heathkit Q-Multiplier; modified front end; five bandspread coils including 21 mc and GC coil for Top Band; complete with power pack; £23. Also Panda PR-120V, perfect and TVI-proof, £45. Also Grundig TK-819 tape recorder (95 gns. model), £35 or nearest. Also Clavioline (electronic keyboard) and stand, full working order, £35 or nearest.—G6QB, 186 Winchelsea Road, Hastings, Sussex. (Tel.: Pett 3014.)

CR. 100, excellent condition, £18. 120w. table-top Tx, 3.5 to 28 mc AM/CW, complete with PSU and high-level modulator, parallel 807's, fully screened and TVI-proofed, mains filter and LP O/P filter, £19 o.n.o.? Buyer collects.—J. C. Beal, 34 Primrose Gardens, Bushey, Herts. (Road number incorrect in January advertisement.)

TWO 4X150 valve holders wanted. SALE: G2UJ 2-metre converter, G4BI cabinet, perf., £8 10s.; 3.5 mc Command Transmitter, 55s.; Philco car radio short wave converter, new, 55s. — G6MN, Castle-mount, Worksop, Notts.

AR 77E 0.54-31 mc, separate amateur bandspread scales, crystal filter, S-meter, recent re-valve and re-alignment, speaker, phones, manual, £15. Transport arranged, if desired.—Box No. 2567, Short Wave Magazine, Ltd., 55 Victoria Street, London, S.W.1. (S.E. LONDON.)

MINIMITTER Amateur Band converter, 1.5 mc output, 200-240 or 6-volt supply, mint condition, three months' use only, £8 10s.; delivery U.K.—Box No. 2568, Short Wave Magazine, Ltd., 55 Victoria Street, London, S.W.1.

GELOSO 207 Rx, 210 Tx, xtal mike, bug key, Z-Match with built-in moni-match and dummy load, Class-D wavemeter, low-pass filter; all mint condition; £60 (no offers).—Box No. 2569, Short Wave Magazine, Ltd., 55 Victoria Street, London, S.W.1.

COMPLETE STATION, 55 watts CW, 10 watts phone, Top Band to 20 metres; ideal beginner; TA-12 Tx, 52 Rec., etc.; £16. Buyer collects; s.a.e. details. Will split.—G3JIC, 21 The Grove, Windle, St. Helens, Lancs.

MOBILE two-metre transmitter-receiver, case size (10 ins. x 5 ins. x 7 ins.), complete with power unit, £40; offers considered.—Fenton, Niarbyl, Gay Bowers, Danbury, Chelmsford. (Danbury 518.)

AR 88LF for sale, in good condition; will deliver up to 30 miles; £33. — Duke, 42 Gypsy Lane, Gt. Amwell, Nr. Ware, Herts. (Phone Stanstead Abbots 147.)

GENUINE BARGAINS: Two RCA communication receivers. AR88D; excellent condition and performance; buyer collects, Croydon area; £23 each (no offers).—Box No. 2570, Short Wave Magazine, Ltd., 55 Victoria Street, London, S.W.1.

WANTED: Top Band phone Tx, plate and screen mod.; must be self-contained with p/supply; neat appearance essential.—Details and price required to: Box No. 2571, Short Wave Magazine, Ltd., 55 Victoria Street, London, S.W.1.

FOR SALE: Genuine AR88 dB tuning meter, brand-new and boxed, 62s., inclusive of postage. Spares also available for AR88 D/LF; send s.a.e. for list. — A. J. Reynolds, 139 Waller Road, New Cross, London, S.E.14. (Telephone: New Cross 1443 after 7.30 p.m.)

SPECIAL AMATEUR LICENCE MORSE COURSE

COMPLETELY NEW METHOD takes all the drudgery out of learning Morse. Passes secured in all cases, even after previous failures.

By using **SPECIALLY** prepared recordings (3 speed L.P. player required) students learn automatically and without effort, perfect Morse in half the time required by any other method. Please S.A.E. for booklet. Tape/Disc/Tape Service also available.

G3HSC, 45 GREEN LANE, PURLEY, SURREY

NYLON • P.T.F.E

ROD, BAR, SHEET, TUBE, STRIP, WIRE
No Quantity too small List on application

**BRASS, COPPER, BRONZE,
ALUMINIUM, LIGHT ALLOYS**

H. ROLLET & CO. LTD.

6, CHESHAM PLACE, LONDON, S.W.1

BELgravia 4300

Works: 36 ROSEBERY AVENUE, LONDON, E.C.1

Branches at LIVERPOOL, MANCHESTER, BIRMINGHAM, LEEDS

G2ACC offers you . . .

A proven dependable service

We have been established 27 years and are one of the original pre-war mail order businesses.

- All the best makes from one source.
- Aluminium chassis, paxolin and ceramic rotary switches made to individual design.
- A 56 page illustrated catalogue No. 12 Your buying guide for short wave, broadcast and transmitting components. 9d. post free (refundable on first order). U.K. and H.M. Forces anywhere.

SOUTHERN RADIO & ELECTRICAL SUPPLIES

So-Rad Works Redlynch Salisbury Wiltshire

Telephone Downton 207

DALE

UNITED KINGDOM DISTRIBUTORS FOR

hallicrafters

NEW!

HALLICRAFTERS HT-41. Linear. Coverage 80-10 metres. New 7094 beam power pentodes. RF meter. Pi-network. Drive 20 watts up. All circuits metered. SSB, CW, AM. **£190**

HALLICRAFTERS SX-115. Most up to date triple conversion ham receiver. Direct frequency reading to less than 1 Kc. Separate detectors and limiters for SSB/CW and AM. **£285**

HALLICRAFTERS HA-2. This new transverter converts your 10 metre setup for 2 metre transmission and reception. 120 watts SSB, AM, CW, with 5894 final. Nuvistor in RX front end.
Price to be announced

HALLICRAFTERS HA-4. Transistorised T.O. Keyer. Advanced circuitry ensures correct ratio of dot-to-space-to-dash. Two ranges 8-18 and 18-50 w.p.m. Monitor speaker. **£30**

ALL PRICES INCLUDE DELIVERY

WE COMPLETELY GUARANTEE EVERYTHING WE SELL

SEND FOR NEW
CATALOGUE NOW . . .

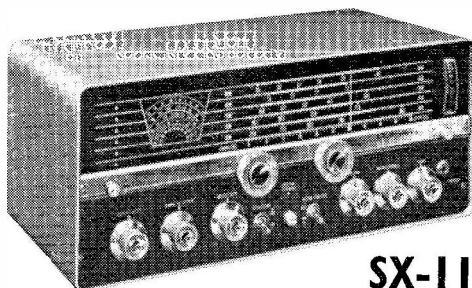

SX-110

The new SX-110 combines those qualities desirable to the short-wave enthusiast and the Amateur who require an inexpensive unit incorporating those features normally found in larger models. Included are a temperature compensated oscillator and bandspread calibration for 10, 15, 20, 40 and 80 metre Amateur bands.

DALE ELECTRONICS

109 JERMYN STREET, LONDON, S.W.1

Whitehall 4856

EVERYTHING FOR THE ENTHUSIAST

AERIAL EQUIPMENT

TWIN FEEDER. 300 ohm twin ribbon feeder similar K25. 6d. per yard. K35B Telcon (round) 1/6 per yard. Post on above feeder and cable, 1/6 any length.

COPPER WIRE, 14G, H/D, 140 ft., 17/-; 70 ft., 8/6, post and packing 2/-. Other lengths pro rata.

RIBBED GLASS 3" AERIAL INSULATORS. 1/9 each, P. & P. 1/6 up to 12.

FEEDER SPREADERS. 6" Ceramic type F.S., 10d. each. Postage 1/6 up to 12.

CERAMIC CENTRE PIECE for dipoles, Type AT, 1/6 each. P. & P. 1/-.

2 METRE BEAM, 5 element W.S. Yagi. Complete in box with 1" to 2 1/2" masthead bracket. Price 49/-, P. & P. 3/6.

SUPER AERIAL, 70/80 ohm coax, 300 watt very low loss, 1/8 per yard. P. & P. 2/-.

FOR THE DX ENTHUSIAST MOSLEY TRAP BEAMS

Vertical 3 Band V3 ... £7 10s.

3 Band 3EL Beam TA 33 dr. £24 15s.

Also the **NEW Single Band Power Beams.** Send for details.

50 ohm, 300w. 1/2" coax Low loss.

Ideal for Mosley and other beams, 1/9 per yd. P. & P. 2/-.

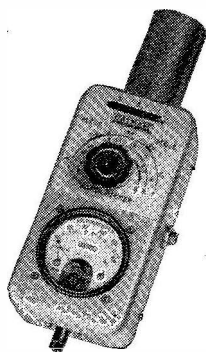

BAND CHECKER MONITOR

This new, sensitive, absorption wavemeter is fitted with a 0-500 microammeter and is also a most useful phone monitor. Covers 3.5-35 m/c/s. in 3 switched bands.

A "MUST" 3 gns. AT ONLY

FOR THE MOBILEER

ROTARY TRANSFORMERS

Miniature 12v. in 360v., 30 Ma or 310v., 70 Ma. 12/6 each or 22/- for two. P. & P. 2/- 6v. in 250v., 125 Ma, only 17/6, P. & P. 3/-.

PACKARD BELL, Pre-Amp Model K. Complete with Leads, Plugs and Valves. P.P. Input and Output Transformers, all in smart 2-piece metal screening box, 17/6 each. Plus 2/6 P. and P.

* No. C.O.D. on orders under £1. Please print name and address.

TOUGH POLYTHENE LINE. Type MLI (100 lbs.) 2d. per yard, or 12/6 for 100 yards. Type ML2 (220 lbs.) 4d. per yard, or 25/- per 100 yards, post free.

ABSORPTION WAVEMETERS. 3.00 to 35.00 Mc/s. in 3 Switched Bands. 3.5, 7, 14, 21 and 28 Mc/s. Ham Bands marked on scale. Complete with indicator bulb. A MUST for any Ham Shack. ONLY 22/6 EACH. Post free.

VARIABLE CONDENSERS. All brass with ceramic end plates and ball race bearings. 50pf, 5/9, 100-6/6, 160, 7/6, 240, 8/6 and 300pf, 9/6. Extension for ganging, P. & P. 1/-.

RACK MOUNTING PANELS: 19" x 5 1/2", 7", 8 1/2", or 10 1/2", black crackle finish, 5/9, 6/6, 7/6, 9/- respectively. P. & P. 2/-.

NATIONAL HRO CRYSTAL FILTER UNITS. 455 kc/s with Crystal, Sel. and Phasing Controls. New, boxed, only 19/6, P. & P. 1/6.

GELOSO VFO UNITS. 4/102 with new dial and escutcheon. Outputs on 80, 40, 20, 15 and 10. For 2-807 or 6146 Tubes. Only £8.5.0. 3 valves to suit, 24/-, ALL POST FREE.

MIKE CABLE. 1st Grade, 9d. yd. plus postage.

12-CORE SCREENED CABLE. 2/- yd.

10-CORE (5 PAIRS) SCREENED CABLE, 1/8 yd. All wires, P. & P. 1/6.

CHAS. H. YOUNG LTD.

Dept. 'S,' 110 Dale End, Birmingham. CENTRAL 1635

A SELECTION FROM THE WORLD-FAMOUS
Easy-to-build kit-sets of highest quality at lower cost



AMATEUR TRANSMITTER, Model DX-100U. Covers all amateur bands: 160-10m., 150w. D.C. input; self-contained with power supply, modulator and V.F.O. **£81 10 0**

SINGLE SIDEBAND ADAPTER, Model SB-10U. May be used with most A.M. transmitters. Less than 3w. R.F. input power required for 10w. output. Operation on 80, 40, 20, 15 and 10m. bands on U.S.B., L.S.B. or D.S.B. ... **£37 6 0**

AMATEUR TRANSMITTER, Model DX-40U. Compact and self-contained. 80-10m. Power input 75w. CW, 60w. peak, CC phone. Output 40w. to aerial. Provision for V.F.O. ... **£32 10 0**

HI-FI F.M. TUNER. Tuning range 88-108 Mc/s. For your convenience, it is available in two units sold separately: Tuning unit FMT-4U with 10.7 Mc/s. I.F. output (£3 5 0 incl. P.T.) I.F. Amp. FMA-4U with cabinet and valves (£11 11 0) ... **£14 16 0**

GRID DIP METER, Model GD-1U. Continuous coverage 1.8-250 Mc/s. Self-contained, with 5 plug-in coils. **£10 9 6**

TRANSISTORISED GD METER. **£10 8 6**

R.F. SIGNAL GENERATOR, Model RF-1U. Covers extended frequency in 6 bands: 100 Kc/s-100 Mc/s. and up to 200 Mc/s. on calibrated harmonics; up to 100 mV. output on all bands ... **£11 18 0**

RES.-CAP. BRIDGE, Model C-3U. Measures capacity 10pF-1,000µF; resistance 100Ω-5MΩ and power factor; 5-450v. test voltages; with safety switch **£8 6 6**

AUDIO SIGNAL GENERATOR, Model AG-9U. 10 c/s.-100 Kc/s., switch selected; distortion less than 0.1%; 10v. sine wave output measured in volts and dB's. ... **£19 19 6**

VALVE VOLTMETER, Model V-7A. Measures volts to 1,500 (D.C. and RMS) and 0-1000 pk. to pk.; Res. 0.1Ω-1,000MΩ. D.C. input imped. 11MΩ; with test prods, leads and standardising battery ... **£13 0 0**

R.F. PROBE, Model 309-CU. Extends the freq. range of our V-7A. to 100 Mc/s. and gives useful voltage indication up to 300 Mc/s. ... **£1 9 6**

5" OSCILLOSCOPE, Model O-12U. Has wide-band amplifiers essential for TV servicing, F.M. alignment, etc. Vertical freq. response 3 c/s. to over 5 Mc/s. without extra switching. T/B covers 10 c/s.-500 Kc/s. in 5 ranges ... **£36 10 0**

ELECTRONIC SWITCH, Model S-3U. 'Scope trace doubler. Enables a single beam 'scope to give simultaneous traces of two separate and independent signals; switching rates about 150, 500, 1,500, 5,000 and 15,000 c/s. **£10 15 6**

CAPACITANCE METER, Model CM-1U. Direct-reading 4½" scale; full scale ranges, 0-100µF, 0-1,000µF, 0-0.01µF, 0-0.1µF. ... **£14 15 0**

AUDIO WATTMETER, Model AW-1U. Up to 25w. continuous; 50w. intermittent ... **£14 14 0**

THE "MOHICAN" GENERAL COVERAGE RECEIVER, Model GC-1U.

Excellent fully transistorised mobile or fixed station receiver, in the forefront of design, for amateurs or short-wave listeners, with 4 piezo-electric transistors, 10 transistors, variable tuned B.F.O., Zener diode stabiliser, telescopic whip aerial, tuning meter, slide rule dial (about 70") and printed circuit boards ... **£38 15 0**

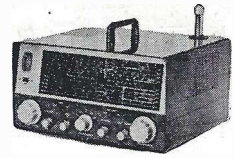

GC-1U

VAR. FREQ. OSCILLATOR, Model VF-1U. Calibrated 160-10m. Fund. outputs on 160 and 40m. Ideal for our DX-40U or similar transmitters **£11 2 0**

TAPE RECORDING/PLAYBACK AMPLIFIER. Thermometer type recording indicators, press-button speed compensation and input selection, printed circuit board. ... Mono Model TA-1M **£18 2 6** Stereo Model TA-1S **£23 6 0**

HI-FI 16W STEREO AMPLIFIER, Model S-88. 20mV basic sensitivity (4mV available 7/6 extra); ganged controls; stereo/mono gram., radio and tape recorder inputs; push-button selection; two-tone grey metal cabinet ... **£26 12 6**

6W STEREO AMPLIFIER, Model S-33. 0.3% distn. at 2.5 w/chl. Inputs for radio/tape and gram., stereo/mono. ... **£12 8 6**

HI-FI SPEAKER SYSTEM, Model SSU-1. Ducted port bass reflex cabinet "in the white"; twin speakers. With legs (£11/18/6) ... **£10 17 6**

HI-FI EQUIPMENT CABINETS. Range now available from **£11 5 6** to **£17 18 6**

"COTSWOLD" HI-FI SPEAKER SYSTEM. Acoustically designed enclosure "in the white"; 26" x 23" x 15½" housing as 12" bass speaker with 2" speech coil, elliptical middle speaker to cover the full frequency range of 30-20,000 c/s.; with cross-over unit, level control, etc. ... **£21 19 0**

SHORT WAVE TRANSISTOR PORTABLE, Model RSW-1. Two Short, Trawler and Medium bands ... **£22 10 0**

DUAL-WAVE TRANSISTOR PORTABLE, Model UXR-1. Medium and long. ... **£14 18 6**

2½" PORTABLE SERVICE 'SCOPE, Model OS-1. Compact, ideal for servicing and general laboratory work. Size: 5" x 8" x 14½" long; weight 10½lb. Y amplifier sensitivity 10mV/cm, bandwidth 10 c/s., 2.5 Mc/s. Time base 15 c/s.-150 Kc/s. Printed circuit board and 2½" c.r.t. ... **£19 10 0**



S-88



FM TUNER



VF-1U



DX-40U



DX-100U



THE "GLOUCESTER" EQUIPMENT CABINET

Free delivery in U.K.
Deferred terms available in U.K. over £10.

Please send me FREE CATALOGUE (Yes/No)
Full details of model(s).....

NAME.....
(BLOCK CAPITALS)
ADDRESS.....

SW2

DAYSTROM LIMITED

DEPT. SW2, GLOUCESTER, ENGLAND

A member of the Daystrom Group,
manufacturers of the

WORLD'S LARGEST SELLING ELECTRONIC KITS